

FROM THE LIBRARY OF THE CALIFORNIA HISTORICAL RADIO SOCIETY

BART LEE, K6VK, ARCHIVIST; SCANNED BY JOHN STAPLES, W6BM

LAST CHAPTER, G: MARCONI'S METHOD [1902]



A HISTORY  
OF  
WIRELESS TELEGRAPHY

INCLUDING SOME BARE-WIRE PROPOSALS  
FOR SUBAQUEOUS TELEGRAPHS

BY

J. J. FAHIE

MEMBER OF THE INSTITUTION OF ELECTRICAL ENGINEERS, LONDON, AND OF  
THE SOCIÉTÉ INTERNATIONALE DES ÉLECTRICIENS, PARIS;

AUTHOR OF

'A HISTORY OF ELECTRIC TELEGRAPHY TO THE YEAR 1887,' ETC.

WITH FRONTISPIECE AND ILLUSTRATIONS

THIRD EDITION, REVISED

NEW YORK  
DODD, MEAD, AND CO.  
EDINBURGH AND LONDON  
WILLIAM BLACKWOOD AND SONS  
MCMII

*All Rights reserved*



DERSTED



AMPERE



FARADAY



HENRY

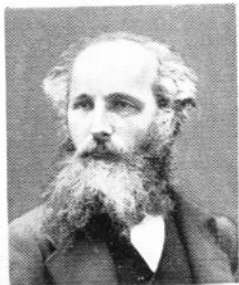

CLERK-MAXWELL



HERTZ

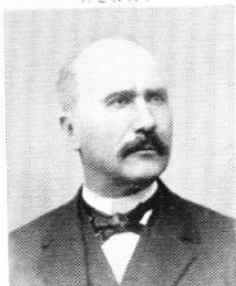

BRANLY



LODGE



RIGHI



PREECE



WILLOUGHBY SMITH



MARCONI

THE ARCH-BUILDERS OF WIRELESS TELEGRAPHY.

# A HISTORY OF WIRELESS TELEGRAPHY

INCLUDING SOME BARE-WIRE PROPOSALS  
FOR SUBAQUEOUS TELEGRAPHS

BY

J. J. FAHIE

MEMBER OF THE INSTITUTION OF ELECTRICAL ENGINEERS, LONDON, AND OF  
THE SOCIÉTÉ INTERNATIONALE DES ÉLECTRICIENS, PARIS;

AUTHOR OF

'A HISTORY OF ELECTRIC TELEGRAPHY TO THE YEAR 1887,' ETC.

WITH FRONTISPIECE AND ILLUSTRATIONS

THIRD EDITION, REVISED

NEW YORK  
DODD, MEAD, AND CO.  
EDINBURGH AND LONDON  
WILLIAM BLACKWOOD AND SONS  
MCMII

All Rights reserved

remain anywhere in proximity under the water, communication can usually be kept up, the telephone receivers used in this way being so exceedingly sensitive that they will respond to the very minute traces of current picked up by the broken end on the receiving side from that which is spreading out through the water in all directions from the broken end on the sending side." (See Mr Brown's patent specification, No. 30,123, of December 31, 1896.)

Recently he has been successful in bridging over in this way a gap in one of the Atlantic cables; but in this he has done nothing more than the present writer did in 1881, and Mr Willoughby Smith in 1887.

#### G. MARCONI'S METHOD.

"Even the lightning-elf, who rives the oak  
And bars the tempest, shall bow to that yoke,  
And be its messenger to run."

—*Supple's Dampier's Dream.*

We now come to the crowning work of Mr Marconi in wireless telegraphy; but before describing this method it will be desirable to make ourselves acquainted with the principles involved in the special apparatus which he employs, and which differentiates his system from all those that have hitherto occupied us. For this we need only go back a few years, and make a rapid survey of the epoch-marking discoveries of a young German philosopher, Heinrich Hertz.<sup>1</sup>

To properly appreciate the work of Hertz we must carry

<sup>1</sup> Hertz was born in Hamburg, February 22, 1857, and died in Bonn, January 1, 1894. For interesting notices of his all too brief life, see, *inter alia*, the 'Electrician,' vol. xxxiii. pp. 272, 299, 332, and 415.

our minds back two hundred years, to the time when Newton made known to the world the law of universal gravitation. Here, in the struggle between Newtonianism and the dying Cartesian doctrine, we have the battle-royal between the rival theories of action-at-a-distance and action-by-contact. The victory was to the former for a time; and in the hands of Bernouilli, and, subsequently, of Boscovich, the doctrines of Newtonianism were carried far beyond the doctrines of the individual Newton. In fact, Newton expressed himself as being opposed to the notion of matter acting where it is not; though, as we see by his support of the emission theory of light, he was not prepared to accept the notion of a luminiferous ether. Newton, however, suggested that gravitation might be explained as being due to a diminution of pressure in a fluid filling space. Thus the doctrine of an empty space, requiring the infinitely rapid propagation of a distance-action, held the field, and was recognised by scientists of the eighteenth century as the only plausible hypothesis.

History repeats itself; and again the battle-royal was fought, this time, early in the nineteenth century, in favour of the ether hypothesis; and action-at-a-distance was mortally wounded. Before the phenomena of interference of light and the magnetic and electro-static researches of Faraday, both the idea of empty space action and that of the emission of light failed; and the propagation of force through the ether, and of light by vibratory conditions of the ether, came to be held as necessary doctrines. Later still,<sup>1</sup> Maxwell assumed the existence of, and investigated the state of, stress in a medium through which electromagnetic action is propagated. The mathematical theory

<sup>1</sup> October 1864, in his paper on the Dynamical Theory of the Electro-Magnetic Field, 'Phil. Trans.,' vol. 155. See also his great work, 'Electricity and Magnetism,' published in 1873.

which he deduced gives a set of equations which are identical in form with the equations of motion of an infinite elastic solid; and, on this theory, the rate of propagation of a disturbance is equal to the ratio of the electro-magnetic and electro-static units. The experimental determination by Maxwell and others, that this ratio is a number equal to the velocity of light in ether in centimetres per second, is a fact which gave immense strength to the Maxwellian hypothesis of identity of the light and electro-magnetic media. But, although this is the case, the Maxwellian hypothesis, even when taken in conjunction with the experimental support which he deduced for it, fell far short of being a complete demonstration of the identity of luminous and electro-magnetic propagation.<sup>1</sup>

To the genius of Hertz we owe this demonstration. One of the most important consequences of Maxwell's theory was that disturbances of electrical equilibrium produced at any place must be propagated as waves through space, with a velocity equal to that of light. If this propagation was to be traced through the small space inside a laboratory, the disturbances must be rapid, and if a definite effect was to be observed, they must follow each other at regular intervals; in other words, periodical disturbances or oscillations of extreme rapidity must be set up, so that the corresponding wave-length, taking into account the extraordinarily high velocity of propagation (186,000 miles per second), may be only a few inches, or at most feet. Hertz was led to an experiment which satisfied these conditions, and thus supplied the experimental proof which Maxwell and his school knew must come sooner or later.

The oscillatory nature of the discharge of a Leyden jar, under certain conditions, was theoretically deduced by Von Helmholtz in 1847; its mathematical demonstration was

<sup>1</sup> Lord Kelvin's Address, Royal Society, November 30, 1893.

given by Lord Kelvin in 1853; and it was experimentally verified by Feddersen in 1859. When a Leyden jar, or a condenser, of an inductive capacity  $\kappa$ , is discharged through a circuit of resistance  $R$  and self-induction  $L$ , the result is an instantaneous flow, or a series of oscillations, according as  $R$  is greater, or less, than  $2\sqrt{\frac{L}{\kappa}}$ ; and in the latter case the oscillatory period or amplitude is given in the equation—

$$T = 2\pi \sqrt{KL}$$

where  $\pi$  is the constant 3.1415 ('Phil. Trans.,' June 1853).<sup>1</sup>

In his collected papers<sup>2</sup> Hertz tells us that his interest in the study of electrical oscillations was originally awakened by the announcement of the Berlin prize of 1879, which was to be awarded for an experimental proof of a relation between electro-dynamic forces and dielectric polarisation in insulators. At the suggestion of his master and friend, Von Helmholtz, the young philosopher took up the inquiry, but soon discovered that the then known oscillations were too slow to offer any promise of success, and he gave up the immediate research; but from that time he was always on the look-out for phenomena in any way connected with the subject. Consequently, he immediately recognised the importance of a casual observation which in itself and at another time might have been considered as too trivial for further notice. In the collection of physical apparatus at Karlsruhe he found an old pair of so-called Riess's or Knochenhauer's spirals—short flat coils of insulated wire,

<sup>1</sup> In the old 'Electrician,' vol. iii. p. 101, there is an interesting paper on "The Oscillatory Character of Spark Discharges shown by Photography." For a concise exposition of the theory of electrical oscillations, see Prof. Edser's paper, 'Electrical Engineer,' June 3, 1898, and following numbers.

<sup>2</sup> 'Electric Waves,' London, 1893. For an interesting account of pre-Hertzian observations, see Lodge's 'The Work of Hertz,' p. 61; also Appendix D of this work.

with the turns all in the same plane (? Prof. Henry's spirals). While performing some experiments with them at a lecture he was giving, he noticed that the discharge of a very small Leyden jar, or of a small induction coil, passed through the one was able to excite induced currents in the other, provided that a small spark-gap was made in the circuit of the first spiral. Thus was made the all-important discovery of the "effective spark-gap" which started Hertz on the road of his marvellous investigations.

A very little consideration of this phenomenon enabled him, even at this early stage, to lay down the following propositions:—

1. If we allow a condenser, such as a Leyden jar, of small capacity, to discharge through a short and simple circuit with a spark-gap of suitable length, we obtain a sharply defined discharge of very short duration, which is the long-sought-for sudden disturbance of electrical equilibrium—the *exciter* of electrical vibrations.

2. Such vibrations are capable of exciting in another circuit of like form resonance effects of such intensity as to be evident even when the two circuits are separated by considerable distances. In this second circuit Hertz had found the long-sought-for *detector* of electric waves.

With the exciter to originate electric waves and the detector to make them evident at a distance, all the phenomena of light were, one after another, reproduced in corresponding electro-magnetic effects, and the identity of light and electricity was completely demonstrated.<sup>1</sup>

In his paper "On very Rapid Electric Oscillations," Hertz occupied himself with some of these phenomena. As an exciter he used wire rectangles, or simple rods (fig. 30) to the ends of which metallic cylinders or spheres were con-

<sup>1</sup> See Appendix A for a clear exposition of the views regarding the relation of the two *before* and *after* Hertz.

nected, the continuity being broken in the middle where the ends were provided with small spherical knobs between

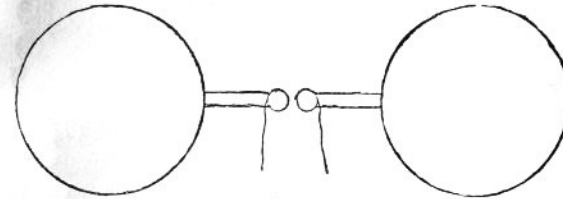

Fig. 30.

which the sparks passed. The exciter was charged by an ordinary Ruhmkorff induction coil of small size.

The detector was mostly a simple rectangle or circle of wire (fig. 31), also provided with a spark-gap. When vibrations are set up in the detector and sparks pass across the gap, the greater length of these sparks indicates the greater intensity of the received wave impacts. When, therefore, the dimensions of the detector are so adjusted as to give the maximum sparks with a given exciter the two

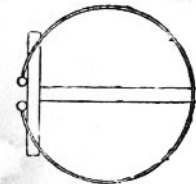

Fig. 31.

circuits are said to be in resonance, or to be electrically tuned. Fortunately this condition of resonance or syntonny is not essential to the excitement of sparks, else wireless telegraphy by Hertzian waves would not be so advanced as it is to-day. Thus, when a good exciter is in action it will cause little sparks between any conducting body in its vicinity and a wire held in the hand and brought near to the body, showing that the influence of the exciter extends to all conducting bodies, and not merely to those which are tuned to it. Of course it still holds good that, *cæteris paribus*, the maximum effect is obtained with resonance.

In the course of his experiments on electric resonance, Hertz observed a phenomenon which for a time was inexplicable. It was seen that the length and brightness of the sparks at the detector were greatly modified by the sparks given off at the exciter. If the latter were visible from the detector spark-gap the sparks given off there were small and hardly perceptible, but became larger and brighter as soon as a screen was placed between the two instruments. By carefully thought-out experiments he showed that this singular action was due solely to the presence of ultra-violet light, breaking down the insulation of the gap and making it, so to say, more conductive. This effect can be shown in another way, by widening the spark-gap of an induction coil beyond the ordinary sparking distance, when, by simply directing a beam of ultra-violet light into the gap, sparking will be resumed.<sup>1</sup>

Having made himself familiar with the phenomena of electrical resonance, Hertz went on to study the propagation of electric vibrations through space—the most difficult, as it is probably the most important, of all his researches.

<sup>1</sup> Prof. K. Zickler has proposed to use this property for telegraphy. At the sending station an arc lamp, which is rich in ultra-violet rays, is provided with a shutter and a lens for directing flashes towards the receiving station. There they are made to impinge on the spark-gap, unduly widened, of an induction coil in action, and allow sparks to pass. These give rise to electric waves which act on the coherer, which in its turn operates a bell, a telephone, or a Morse instrument in the way we shall see later on when we come to speak of the action of the Marconi apparatus. The reflecting lens is made of quartz and not of glass, which does not transmit the ultra-violet rays; but for signalling or interrupting the rays in long and short periods a glass plate is used as the shutter. The interruption of the ultra-violet rays is thus effected without altering the light, which assures secrecy of transmission. Prof. Zickler has in this way signalled over a space of 200 metres, and thinks that with suitable lamps and reflectors the effect would be possible over distances of many kilometres.—'Elektrische Zeitung,' July 1898.

The results he gave to the world in 1888, in his paper "On the Action of a Rectilinear Electric Oscillation on a Neighbouring Circuit." When sparks pass rapidly at the exciter electric surging occurs, and we have a rectilinear oscillation which radiates out into surrounding space. The detectors, whose spark-gaps were adjustable by means of a micrometer screw, were brought into all kinds of positions with respect to the exciter, and the effects were studied and measured. These effects were very different at different points and in the different positions of the detector. In short, they were found to obey a law of radiation which was none other than the corresponding law in optics.

In his paper, "On the Velocity of Propagation of Electrodynamical Actions," he gave experimental proof of the hitherto theoretical fact that the velocity of electric waves in air was the same as that of light, whereas he found the velocity in wires to be much smaller—in the ratio of 4 to 7. For the moment he was puzzled by this result: he suspected an error in the calculations, or in the conditions of the experiment, but—and here he showed himself the true philosopher—he did not hesitate to publish the actual results, trusting to the future to correct or explain the discrepancy. The explanation was soon forthcoming. Messrs E. Sarasin and L. de la Rive of Geneva took up the puzzle, and ended by showing that the deviations from theory were caused simply by the walls of Hertz's laboratory, which reflected the electric waves impinging on them, so causing interferences in the observations. When these investigators repeated the Hertzian experiment with larger apparatus, and on a larger scale, as they were able to do in the large turbine hall of the Geneva Waterworks, they found the rate of propagation to be the same along wires as in air.<sup>1</sup>

<sup>1</sup> 'Comptes Rendus,' March 31, 1891, and December 26, 1892. See also the 'Electrician,' vol. xxvi. p. 701, and vol. xxx. p. 270.

In his paper, "On Electro-dynamic Waves and their Reflection," Hertz further developed this point, and showed the existence of these waves in free space. Opposite the exciter a large screen of zinc plate, 8 feet square, was suspended on the wall; the electric waves emitted from the exciter were reflected from the plate, and on meeting the direct waves interference phenomena were produced, consisting of stationary waves with nodes and loops. When, therefore, Hertz moved the circle of wire which served as a detector to and fro between the screen and the exciter, the sparks in the detector circuit disappeared at certain points, reappeared at other points, disappeared again, and so on. Thus there was found a periodically alternating effect corresponding to nodes and loops of electric radiation, showing clearly that in this case also the radiation was of an undulatory character, and the velocity of its propagation finite.

In a paper, "On the Propagation of Electric Waves along Wires," March 1889, Hertz shows that alternating currents or oscillations of very high frequencies, as one hundred million per second, are confined to the surface of the conductor along which they are propagated, and do not penetrate the mass.<sup>1</sup> This is a very important experimental proof of Poynting's theory concerning electric currents, which he had deduced from the work of Faraday and Maxwell. According to this theory, the electric force which we call the current is in nowise produced *in* the wire, but under all circumstances enters from without, and spreads itself in the metal comparatively slowly, and according to similar laws as

<sup>1</sup> It should be stated here that long ago Prof. Henry, the Faraday of America, held the same views, and proved them, too, by an experiment which is strangely like one of Hertz's, though, of course, he did not explain them as Hertz does. Henry's views are given clearly in two letters addressed to Prof. Kedzie of Lansing, Michigan, in 1876. Being of historical interest, as well as of practical value, I give them entire in Appendix B.

govern changes of temperature in a conductor of heat. If the electric force outside the wire is very rapidly altering in direction or oscillating, the effect will only enter to a small depth *in* the wire; the slower the alterations occur, the deeper will the effect penetrate, until finally, when the changes follow one another infinitely slowly, the electric effect occupies the whole mass of the wire with uniform density, giving us the phenomenon of the so-called current.

In support of this view Hertz devised many beautiful experiments, one or two of which may be described here.

If a primary conductor acts through space upon a secondary conductor, it cannot be doubted that the effect reaches the latter from without. For it can be regarded as established that the effect is propagated in space from point to point, therefore it will be forced to meet first of all the outer boundary of the body before it can act upon the interior of it. But a closed metallic envelope is shown to be quite opaque to this effect. If we place the secondary conductor in such a favourable position near the primary one that we obtain sparks 5 to 6 millimetres long, and then surround it with a closed box made of zinc plate, the smallest trace of sparking can no longer be perceived. The sparks similarly vanish if we entirely surround the primary conductor with a metallic box. It is well known that with relatively slow variations of current the integral force of induction is in no way altered by a metallic screen. This is, at the first glance, contradictory to the present contention. However, the contradiction is only an apparent one, and is explained by considering the duration of the effects. In a similar manner a screen which conducts heat badly protects its interior completely from rapid changes of the outside temperature, less from slow changes, and not at all from a continuous rising or lowering of the temperature. The thinner the screen is,

the more are the rapid variations of the outside temperature felt in its interior.

In our case also the electrical action must plainly penetrate into the interior of the closed box, if we only diminish sufficiently the thickness of the metal. But Hertz did not succeed in attaining the necessary thinness, —a box covered with tinfoil protected completely, and even a box of gilt paper, if care was taken that the edges of the separate pieces of paper were in metallic contact. In this case the thickness of the conducting metal was estimated to be barely  $\frac{1}{20}$  millimetre. To demonstrate this, he fitted the protecting envelope as closely as possible round the secondary conductor, and widened the spark-gap to about 20 millimetres, adding an auxiliary spark-gap exactly opposite to it. The sparks were in this case not so long as in the ordinary arrangement, since the effect of resonance was now wanting, but they were still very brilliant. Between the ends of this envelope, then, brilliant sparks were produced; but on observing the auxiliary spark-gap (through a wire-gauze window in the envelope), not the slightest electrical movement could be detected in the interior.

The result of the experiment is not affected if the envelope touches the conductor at a few points: the insulation of the two from each other is not necessary in order to make the experiment succeed, but only to give it the force of a proof. Clearly we can imagine the envelope to be drawn more closely round the conductor than is possible in the experiment; indeed, we can imagine it to coincide with the outermost layer of the conductor. Although, then, the electrical disturbances on the surface of our conductor are so powerful that they give sparks 5 to 6 millimetres long, yet at  $\frac{1}{20}$  millimetre beneath the surface there exists such perfect freedom from disturbance that it is not

possible to obtain the smallest sparks. We are brought, therefore, to the conclusion that what we call an induced current in the secondary conductor is a phenomenon which is manifested in its neighbourhood, but to which its interior scarcely contributes.

One might grant that this is the state of affairs when the electric disturbance is conveyed through a dielectric, but maintain that it is another thing if the disturbance, as one usually says, has been propagated in a conductor. Let us place near one of the end plates of our primary conductor a conducting-plate, and fasten to it a long, straight wire: we have already seen (in previous experiments) how the effect of the primary oscillation can be conveyed to great distances by the help of this wire. The usual theory is that a wave travels along the wire. But we shall try to show that all the alterations are confined to the space outside and the surface of the wire, and that its interior knows nothing of the wave passing over it.

Hertz arranged experiments first of all in the following manner: A piece about 4 metres long was removed from the wire conductor and replaced by two strips of zinc plate 4 metres long and 10 centimetres broad, which were laid flat one above the other, with their ends permanently connected together. Between the strips along their middle line, and therefore almost entirely surrounded by their metal, was laid along the whole 4 metres' length a copper wire covered with gutta-percha. It was immaterial for the experiments whether the outer ends of this wire were in metallic connection with, or insulated from, the strips: however, the ends were mostly soldered to the zinc strips. The copper wire was cut through in the middle, and its ends were carried, twisted round each other, outside the space between the strips to a fine spark-gap, which permitted the detection of any electrical disturbance taking place



in the wire. When waves of the greatest possible intensity were sent through the whole arrangement there was nevertheless not the slightest effect observable in the spark-gap. But if the copper wire was displaced anywhere a few decimetres from its position, so that it projected just a little beyond the space between the strips, sparks immediately began to pass. The sparks were the more intense according to the length of copper wire extending beyond the edge of the zinc strips and the distance it projected. The unfavourable relation of the resistances was therefore not the cause of the previous absence of sparking, for this relation had not been changed; but the wire being in the interior of the conducting mass was at first deprived of the influence coming from without. Moreover, it is only necessary to surround the projecting part of the wire with a little tinfoil in metallic communication with the zinc strips, in order to immediately stop the sparking again. By this means we bring the copper wire back again into the interior of the conductor.

We can conclude, then, that rapid electric oscillations are unable to penetrate metallic sheets or wires of any thickness, and that it is, therefore, impossible to produce sparks by the aid of such oscillations in the interior of closed metallic screens. If, then, we see sparks so produced in the interior of metallic envelopes which are nearly, but not quite, closed, we must conclude that the electric disturbance has forced itself in through the openings. Let us take a typical case of this kind.

In fig. 31A we have a wire cage *A* just large enough to hold the spark-gap. One of the discs *a* is in metallic connection with the central wire; the other *b* is clear of the wire (which passes freely through the central hole), but is connected to the metallic tube *c*, which completely surrounds (without touching it) the central wire for a length

of 1.5 metre. On sending a series of waves through this arrangement in the direction shown by the arrow, we obtain brilliant sparks at *A*, which do not become materially smaller, if, without making any other alteration, we lengthen the tube *c* to as much as 4 metres.

According to the old theory, it would be said that the wave arriving at *A* penetrates easily the thin metallic disc *a*, leaps across the spark-gap, and travels on in the central wire; but according to the present view, the explanation is as follows: The wave arriving at *A* is quite unable to penetrate the disc *a*; it therefore glides over it, over the outside of the apparatus, and on to the point *d*, 4 metres distant. Here it divides: one part travels on along the wire; the other bends into the interior of the tube, and runs



Fig. 31A.

back in the space between the tube and the wire to the spark-gap, where it gives rise to the sparking. That this view is the correct one is shown by the fact, amongst others, that every trace of sparking disappears as soon as we close the opening at *d* by a tinfoil stopper.

Reviewing his experiments on this subject, Hertz says: "A difference will be noticed between the views here put forward and the usual theory. According to the latter, conductors are represented as those bodies which alone take part in the propagation of electric disturbances; non-conductors are the bodies which oppose this propagation. According to our view, on the contrary, all transmission of electrical disturbances is brought about by non-conductors; conductors oppose a great resistance to any rapid changes in

this transmission. One might almost be inclined to maintain that conductors and non-conductors should, on this theory, have their names interchanged. However, such a paradox only arises because one does not specify the kind of conduction or non-conduction considered. Undoubtedly metals are non-conductors of electric force, and just for this reason they compel it under certain circumstances to remain concentrated instead of becoming dissipated; and thus they become conductors of the apparent source of these forces, electricity, to which the usual terminology has reference."<sup>1</sup>

In the course of his experiments Hertz had succeeded in producing very short electric waves of 30 centimetres in length, the oscillations corresponding to which could be collected by a concave cylindrical mirror and concentrated into a single beam of electric radiation. According to Maxwell's theory of light, such a beam must behave like a beam of light, and that this is the case Hertz abundantly proved in his next paper, "On Electric Radiation." He showed how such radiation was propagated in straight lines like light; that it could not pass through metals, but was reflected by them; that, on the other hand, it was able to penetrate wooden doors and stone walls. He also proved, by setting up metallic screens, that a space existed behind them in which no electric action could be detected, thus producing electric shadows; and, by passing the electric rays through a wire grating, he was able to polarise them, just as light is polarised by passage through a Nicol prism.

<sup>1</sup> As this is a matter of some complexity to all who, like myself belong to the old way of thinking—the *ancien régime*—and as, moreover, it is of great practical importance, especially as regards the proper construction of lightning protectors, and the supply mains of electric light and power, I have thought it useful to give in Appendix B some extracts, which I hope will make the new views intelligible to the ordinary reader. Lodge's 'Modern Views of Electricity' should also be consulted.

Perhaps the most striking experiment of all in this field was his last one, in which he directed the ray on to a large pitch prism weighing 12 cwts.: the ray was deflected, being, in fact, refracted like a ray of light in a glass prism.

Thus he gave to the experimental demonstration of Maxwell's electro-magnetic theory of light its finishing touch, and the edifice was now complete. Hertz's marvellous researches were presented in succession, as rapid and surprising almost as the sparks with which he dealt, to the Berlin Academy of Sciences, between November 10, 1887, and December 13, 1889. They were collected and published in book form, in 1893, under the title of 'Electric Waves' (English translation edited by Prof. D. E. Jones), to which the reader is referred for further information.<sup>1</sup>

Here it will suffice, in conclusion, to briefly sum up the chief results of these epoch-making investigations. In the first place, Hertz has freed us from the bondage of the old theory of action-at-a-distance; and as regards electric and magnetic effects, he has shown that they are propagated through the ether which fills all space and with finite velocity. The mysterious darkness which surrounded those strange distance-actions—that something can act where it is not—has now been cleared away. Further, the identity of the form of energy in the case of two powerful agents in nature has been conclusively established; light and electrical radiation are essentially the same, different manifestations of the same processes, and so the old elastic-solid theory of optics is resolved into an electro-magnetic theory. The velocity of propagation of light is the same as that of electro-magnetic waves, and these in turn obey all the laws of optics. The scope of optics is thus enormously widened; to the ultra-violet, visible, and infra-red rays, with their wave-lengths

<sup>1</sup> Our account of Hertz's investigations is chiefly drawn from Prof. Ebert's paper in the 'Electrician,' vol. xxxiii. pp. 333-335.

of thousandths of a millimetre, are now to be added, lower down the scale, electro-magnetic waves, producible in any length from fractions of an inch to thousands of miles.

Hertz's ordinary waves were many metres long, and he does not appear to have ever worked with waves of less than 30 centimetres. Righi, however, by employing exciters with small spheres, obtained waves of 2.5 centimetres; while Prof. Chunder Bose of Calcutta, using little pellets of platinum, was able to produce them of only 6 millimetres! The smaller the exciter and its pellets the shorter the waves, until we come in imagination to the exciter—the ultimate molecule, whose waves should approximate to light.

The following table compares approximately some of the known vibrations in ether and air :—

Ether vibrations per second—

	billions (?)	=	Röntgen rays.
10,000	" (?)	=	Actinic "
8,000	"	=	Violet "
5,500	"	=	Green "
4,000	"	=	Red "
2,800	"	=	Infra red "
1,000 to 2,000	"	=	Radiant heat.
50 thousands to 2,000 billions		=	Hertzian waves.

Air vibrations per second—

33,000	=	Highest audible note.
4,000	=	Highest musical note.
2,000	=	Highest soprano.
150 to 500	=	Ordinary voice.
32	=	Lowest musical note.
16	=	" audible "

The work of Hertz was immediately taken up, and is now being carried on (doubtless towards fresh conquests, for there is no finality in science) by a whole army of investi-

gators, of whom we need only mention a few—as Lodge, Righi, Branly, Sarasin, and de la Rive—whose discoveries, especially as regards the exciter and detector, more immediately concern us in this history.

The exciter of Hertz, although sufficing for his special purposes, had the disadvantage that the sparks in a short time oxidised the little knobs and roughened their surfaces, which made their action irregular and necessitated their frequent polishing. Messrs Sarasin and de la Rive of Geneva obviated this difficulty by placing the knobs in a vessel containing olive-oil. The effect of this arrangement was at once to augment the sparks at the detector, so that when it was placed close to the exciter the sparks were a perfect blaze; and at 10 metres' distance, with detectors of large diameter (.75 to 1 metre), they were still very bright and visible from afar. It is true that here, too, the oil carbonises in time and loses its transparency; but if a considerable quantity, as two or three litres, be employed, there is no perceptible heating, and the intensity of the sparks is hardly altered, even after half an hour's continuous working. Prof. Righi substituted vaseline-oil, made suitably thick by the addition of solid vaseline. His exciter is composed of two metal balls, each set in an ebonite frame; a parchment envelope connects these frames and contains the oil which thus fills the spark-gap. Righi attributes the increased efficiency of his exciter (1) to the heightening effect which a cushion of (insulating) liquid seems to have on the electric potential which gives rise to the sparks—a sort of (to adopt an expressive French phrase) *reculant pour mieux sauter*; and (2) to some sort of regularising effect making their production more uniform. Like Sarasin and de la Rive, he found that the use of vaseline obviated the necessity of frequent cleaning of the knobs, for even after long usage, when the liquid had become black and a deposit of carbon had formed

on the opposing surfaces, the apparatus continued to work satisfactorily. Righi also found that solid knobs gave better results than hollow ones, the oscillations in the former case being perceptible in the detector at nearly double the distance attained in the latter case.

The detector usually employed by Hertz consisted of a metal wire bent into a rectangle or a circle (see fig. 31), and terminated by two little knobs between which the sparks played. But this form is not obligatory: any two distinct conducting surfaces separated by a spark-gap will serve equally well. Many kinds of detectors have been employed, but in this place we need only concern ourselves with those of the microphonic order, which alone enter into the construction of the Marconi system of telegraphy.<sup>1</sup>

Just mentioning the well-known electrical behaviour of selenium under the action of light; the fact observed by Prof. Minchin that his delicate "impulsion-cells" were affected by Hertzian waves; the Righi detector, consisting of thin bands of quicksilver (as used for mirrors) rendered discontinuous by cross-lines lightly traced with a diamond; and the original Lodge "coherer," consisting of a metallic point lightly resting on a metal plate,<sup>2</sup>—we come to the special form known as Branly's detector, or, as he prefers to call it, the radio-conductor.

The observance of the phenomena underlying Branly's detector goes back further than is usually supposed. Thus, Mr S. A. Varley, as long ago as 1866, noticed some of them,

<sup>1</sup> For other forms of detectors, based on physiological, chemical, electrical, thermal, and mechanical principles, see Lodge's 'The Work of Hertz and his Successors,' pp. 25, 56.

<sup>2</sup> For the first suggestions of Lodge's detector see his paper, "On Lightning - Guards for Telegraphic Purposes," 'Jour. Inst. Elec. Engs.,' vol. xix. pp. 352-354. Even before this the learned professor succeeded in detecting electric waves by means of a telephone, 'Jour. Inst. Elec. Engs.,' vol. xviii. p. 405.

and applied them in the construction of a lightning protector for telegraph apparatus.

In his paper read before the British Association (Liverpool meeting, 1870), he says:—

"The author, when experimenting with electric currents of varying degrees of tension, had observed the very great resistance which a loose mass of dust composed even of conducting matter will oppose to electric currents of moderate tension.

"With a tension of, say, fifty Daniell cells, no appreciable quantity will pass across the dust of blacklead or fine charcoal powder loosely arranged, even when the battery poles are approached very near to one another.

"If the tension be increased to, say, two or three hundred cells, the particles arrange themselves by electrical attraction close to one another, making good electrical contact, and forming a channel or bridge through which the electric current freely passes.

"When the tension was still further increased to six or seven hundred cells the author found the electricity would pass from one pole to the other through a considerable interval of the ordinary dust which we get in our rooms, and which is chiefly composed of minute particles of silica and alumina mixed with more or less carbonaceous and earthy matters.

"Incandescent matter offers a very free passage to electrical discharge, as is indicated by the following experiments. The author placed masses of powdered blacklead and powdered wood charcoal in two small crucibles; no current would pass through these masses whilst they were cold, however close the poles were approached, without actually touching. The battery employed in this experiment was only twelve cells.

"The crucibles were then heated to a red heat, and electricity freely passed through the heated powder; and on



doubt, from an examination of the bridges afterwards, that under the influence of a high tension discharge connection was made between the two metallic points by a bridge of conducting matter, arranged closely together, and if the instruments *had been shaken to loosen the powder*, all would have been put right."<sup>1</sup>

In the little-known researches of the Italian professor, Calzecchi-Onesti, we find this curious phenomenon again

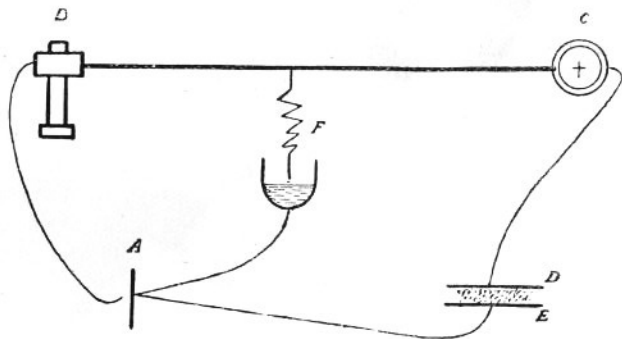

Fig. 33.

cropping up, and in a form more apposite from our present point of view. In 1884-85 Prof. Calzecchi-Onesti found that copper filings heaped between two plates of brass were conductors or non-conductors according to the degree of heaping and pressure, and that in the latter case they could be made conductors under the influence of induction. Fig. 33 illustrates his experiment. In the circuit of a small battery A is placed a telephone B, a galvanometer C, and two brass plates D E, separated by the copper filings. So long as the short-circuit arrangement F (a wire dipping into mercury) is

<sup>1</sup> Sir Wm. Preece tells us the arrangement acted well, but was subject to what we now call coherence, which rendered the cure more troublesome than the disease, and its use had to be abandoned.

open, the galvanometer shows traces of a very feeble current across the filings; but, on dipping the wire for a moment into the mercury and then withdrawing it, a sharp click is heard in the telephone, and the galvanometer indicates the passing of a strong current, showing that the filings must now be conductors. This change he traced to the induced current of the telephone coil (the extra-current *direct*) at the moment of opening the short-circuit. He repeated this experiment with various powders or filings of metal, and ended by showing that rapid interruptions of a circuit containing an inductance coil, or contact with an electrified body, or electro-static discharges were sufficient to make the filings conductive.

For these experiments Calzecchi-Onesti had actually constructed a glass tube (35 millimetres long and 10 millimetres internal diameter) only differing from that shown in fig. 34 in that it was revolvable on its axis, for the purpose of, as we now say, decohering the particles, one revolution or less of the tube sufficing for this purpose.

These observations were published in 'Il Nuovo Cimento,' October 15, 1884, and March 2, 1885,<sup>1</sup> but attracted no attention; and it was only after Prof. E. Branly, of the Catholic University of Paris, had published his results in 1890 that the earlier discoveries of Varley and Onesti came to be remembered and appreciated at their proper value.

Prof. Branly's investigations are very clearly described in 'La Lumière Électrique, May and June 1891.'<sup>2</sup> As this now classic paper deals with facts which are at the very

<sup>1</sup> See also 'Jour. Inst. Elec. Engs.,' vol. xvi. p. 156. In March 1886 Calzecchi-Onesti suggested the use of his tube as a detector of seismic movements, thinking that the conductivity of the filings, imparted by one or other of the above means, would be destroyed by even the smallest earth movement.

<sup>2</sup> See also an abstract in the 'Electrician,' vol. xxvii. pp. 221, 448.

foundation of the Marconi system, I give some extracts from it in Appendix C. Here, therefore, I need only say that Branly verified and extended Calzecchi-Onesti's observations, and made the further (and for our purpose *vital*) discovery that conducting power was imparted to filings by electric discharges in their vicinity, and that this power can be destroyed by simply shaking or tapping them.

The Branly detector, as constructed by Prof. Lodge, is shown in fig. 34. It consists of an ebonite or glass tube about 7 inches long, half-an-inch outer diameter, and fitted at the ends with copper pistons, which can be regulated to press on the filings with any required degree of pressure.

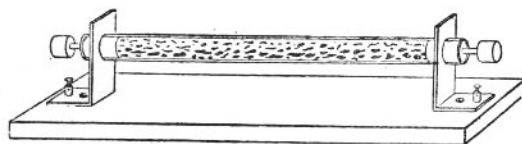

Fig. 34.

To bring back the filings to their normal non-conducting state, Lodge applied to the tube a mechanical tapper, worked either by clockwork or by a trembling electrical mechanism.

These, then, the excitors and the detectors of Hertzian waves, are the bricks and mortar, so to speak, of the Marconi system, and it now only remains to see how they have been shaped and put together to produce a telegraph without connecting wires, which is the realisation of the dream of Steinheil in 1838. And, first, we must notice two or three applications, or suggested applications, which preceded the announcement of Marconi's invention. We do so without in the least meaning to detract one iota from the merit due to the young Irish-Italian inventor,<sup>1</sup> for we believe the idea

<sup>1</sup> Guglielmo Marconi was born in Bologna, 25th April 1874, and was educated at Leghorn, and at the Bologna University, where he was a sedulous attendant at the lectures of Prof. A. Righi.

was entirely original with him, and was unprompted by any suggestions from outside. The history of the applications of science to art shows us that these applications often occur simultaneously to several persons, and it is, therefore, not strange that such is the case in the present instance.

Sir William Crookes, the eminent chemist and electrician, was, I believe, the first to distinctly foresee the applicability of Hertzian waves to practical telegraphy. In a very interesting paper on "Some Possibilities of Electricity,"<sup>1</sup> he gives us the following marvellous forecast of the Marconi system:—

"Rays of light will not pierce through a wall, nor, as we know only too well, through a London fog; but electrical vibrations of a yard or more in wave-length will easily pierce such *media*, which to them will be transparent. Here is revealed the bewildering possibility of telegraphy without wires, posts, cables, or any of our present costly appliances. Granted a few reasonable postulates, the whole thing comes well within the realms of possible fulfilment. At present experimentalists are able to generate electric waves of any desired length, and to keep up a succession of such waves radiating into space in all directions. It is possible, too, with some of these rays, if not with all, to refract them through suitably shaped bodies acting as lenses, and so to direct a sheaf of rays in any given direction. Also an experimentalist at a distance can receive some, if not all, of these rays on a properly constituted instrument, and by concerted signals messages in the Morse code can thus pass from one operator to another.

"What remains to be discovered is—firstly, simpler and more certain means of generating electrical rays of any

<sup>1</sup> 'Fortnightly Review,' February 1892, p. 173. Prof. Lodge has since kindly pointed out to me that about 1890 Prof. R. Threlfall of Sydney, N.S. Wales, threw out a suggestion of the same kind at a meeting of the Australasian Association for the Advancement of Science.

desired wave-length, from the shortest, say a few feet, which will easily pass through buildings and fogs, to those long waves whose lengths are measured by tens, hundreds, and thousands of miles; secondly, more delicate receivers which will respond to wave-lengths between certain defined limits and be silent to all others; and thirdly, means of darting the sheaf of rays in any desired direction, whether by lenses or reflectors, by the help of which the sensitiveness of the receiver (apparently the most difficult of the problems to be solved) would not need to be so delicate as when the rays to be picked up are simply radiating into space, and fading away according to the law of inverse squares. . . .

"At first sight an objection to this plan would be its want of secrecy. Assuming that the correspondents were a mile apart, the transmitter would send out the waves in all directions, and it would therefore be possible for any one living within a mile of the sender to receive the communication. This could be got over in two ways. If the exact position of both sending and receiving instruments were known, the rays could be concentrated with more or less exactness on the receiver. If, however, the sender and receiver were moving about, so that the lens device could not be adopted, the correspondents must attune their instruments to a definite wave-length, say, for example, 50 yards. I assume here that the progress of discovery would give instruments capable of adjustment by turning a screw, or altering the length of a wire, so as to become receptive of waves of any preconcerted length. Thus, when adjusted to 50-yard waves, the transmitter might emit, and the receiver respond to, rays varying between 45 and 55 yards, and be silent to all others. Considering that there would be the whole range of waves to choose from, varying from a few feet to several thousand miles, there would be sufficient secrecy, for the most inveterate curiosity would surely recoil

from the task of passing in review all the millions of possible wave-lengths on the remote chance of ultimately hitting on the particular wave-length employed by those whose correspondence it was wished to tap. By coding the message even this remote chance of surreptitious tapping could be rendered useless.

"This is no mere dream of a visionary philosopher. All the requisites needed to bring it within the grasp of daily life are well within the possibilities of discovery, and are so reasonable and so clearly in the path of researches which are now being actively prosecuted in every capital of Europe, that we may any day expect to hear that they have emerged from the realms of speculation into those of sober fact. Even now, indeed, telegraphing without wires is possible within a restricted radius of a few hundred yards, and some years ago I assisted at experiments where messages were transmitted from one part of a house to another without an intervening wire by almost the identical means here described."<sup>1</sup>

In 1893 Nikola Tesla, the lightning-juggler, proposed to transmit electrical oscillations to any distance through space, by erecting at each end a vertical conductor, connected at its lower end to earth and at its upper end to a conducting body of large surface. Owing to press of other work this experiment was never tried, and so has remained a bare suggestion.<sup>2</sup>

At the Royal Institution, June 1, 1894, and later in the

<sup>1</sup> The experiments here referred to were made in 1879 by Prof. Hughes, who has kindly supplied the author with an account of them. As this interesting and important document was received too late for embodiment in the text, I must ask my readers to refer to Appendix D.

<sup>2</sup> See a full account of Tesla's marvellous researches in 'Jour. Inst. Elec. Eng.' for 1892, No. 97, p. 51; also 'Pearson's Magazine,' May 1899, for some of his latest wonders.



same year at the Oxford meeting of the British Association, Prof. Lodge showed how his form of Branly detector could be made to indicate signals at a distance of about 150 yards from the exciter, but at this time the applicability of his experiment to practical long-distance telegraphy was hardly grasped by him. Referring to this in his 'Work of Hertz' (p. 67, 1897 edition), he says :—

"Signalling was easily carried on from a distance through walls and other obstacles, an emitter being outside and a galvanometer and detector inside the room. Distance without obstacle was no difficulty, only free distance is not very easy to get in a town, and stupidly enough no attempt was made to apply any but the feeblest power so as to test how far the disturbance could really be detected.

"Mr Rutherford, however, with a magnetic detector of his own invention, constructed on a totally different principle, and probably much less sensitive than a coherer, did make the attempt (June 1896), and succeeded in signalling across half a mile full of intervening streets and houses at Cambridge."

Between 1895 and 1896 Messrs Popoff, Minchin, Rutherford, and others applied the Hertzian method to the study of atmospheric electricity; and their mode of procedure, in the use of detectors in connection with vertical exploring rods, was much the same as that of Marconi.

Popoff's arrangement especially is so like Marconi's that we are tempted to reproduce it from the 'Elektritchestvo' of St Petersburg for July 1896. Fig. 35 shows the apparatus, the action of which is easily understood. The relay actuates another circuit, not shown, containing a Richard's register, which plots graphically the atmospheric perturbations.

Prof. Popoff's plans were communicated to the Physico-Chemical Society of St Petersburg in April 1895; and in a

further note, dated December 1895, he adds: "I entertain the hope that when my apparatus is perfected it will be applicable to the transmission of signals to a distance by means of rapid electric vibrations—when, in fact, a sufficiently powerful generator of these vibrations is discovered." We shall see presently that Popoff was looking in the wrong

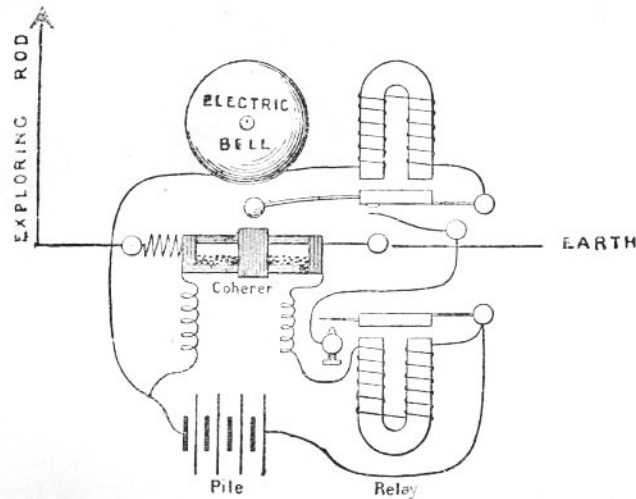

Fig. 35.

direction. It was not so much a more powerful generator (which is easily obtained) that was wanted, as a detector more suitable for signalling purposes than the Branly-Lodge arrangement which he used. Mr Marconi, we shall see, supplied this, and in doing so did the main thing necessary to make Popoff's apparatus a *practical* telegraph.<sup>1</sup>

<sup>1</sup> On hearing of Marconi's success in England, Prof. Popoff tried his apparatus *quasi* telegraph (presumably using more sensitive detectors), and in April 1897 succeeded in signalling through a space of 1 kilometre, then through  $1\frac{1}{2}$ , and finally through 5 kilometres, with vertical wires, 18 metres high.

Sir Wm. Preece tells us that in December 1895 Captain Jackson, R.N., commenced working in the same direction, and succeeded in getting Morse signals through space before he heard of Marconi. His experiments, however, were treated as confidential at the time, and have not been published.

In 1896 the Rev. F. Jervis-Smith had a detector made of finely-powdered carbon, such as is used in incandescent electric lamps (in fact, a kind of carbon-powder telephone), for observing atmospheric electricity; and a little later (in the spring of 1897) he actually applied it to telegraphic purposes over a distance of more than a mile. This form of detector was to a certain extent self-restoring and did not require any tapping device.<sup>1</sup>

Finally, in 1896, Mr Charles A. Stevenson, of whose work in wireless telegraphy we have already spoken (p. 119, *supra*), had the idea of utilising the coherer principle in the construction of a relay of great delicacy.<sup>2</sup> He does not, however, enter into details, merely referring to his "relay with metallic powder between two electromagnets" in the course of some remarks on Prof. Blake's experiments in America (p. 121, *supra*).

I now come to Mr Marconi, whose special application of Hertzian waves to practical telegraphy will be easily understood if my readers have carefully followed me in the preceding pages.

His apparatus for short distances, with clear open spaces, consists of the parts which are shown in diagrammatic form

<sup>1</sup> Recently, October 1898, I have seen it stated that Signor Rovelli has found that a detector made of iron filings acts well, and requires no tapping. See also Prof. Chunder Bose's important researches on potassium as a self-restoring detector—'Proceedings Royal Society,' July 1899.

<sup>2</sup> 'Electrical Review,' August 1896.

in figs. 36, 37, 38, and 39. The apparatus at the sending station consists of a modified Righi exciter A (fig. 36), a Ruhmkorff coil B, a battery of a few cells c, and a Morse key k.

The exciter consists of two solid brass spheres A B (fig. 37), 11 centimetres in diameter and 1 millimetre apart. The spheres are fixed in an oil-tight case of parchment or ebonite, so that an outside hemisphere of each is exposed, the other hemispheres being immersed in vaseline-oil thickened by the addition of a little vaseline. As already explained, the use of oil has several advantages, all of which combine to

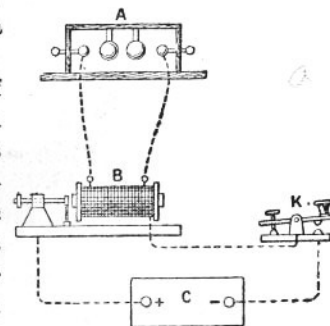

Fig. 36.

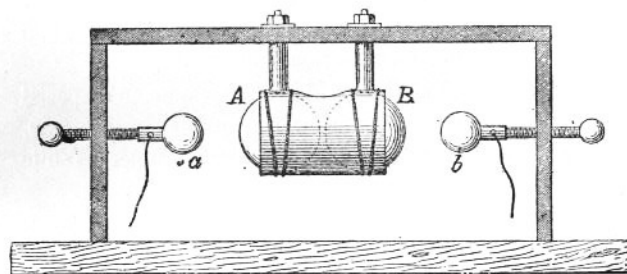

Fig. 37.

increase the effectiveness of the arrangement, and therefore the distance at which the effect can be detected. It keeps the opposing surfaces of the spheres clean and bright, and gives to the electric sparks a more uniform and regular

character, which is best adapted for signalling.<sup>1</sup> Two small balls, also of solid brass, *a b*, are fixed in a line with the large ones, usually about 2.5 centimetres apart, and are capable of adjustment. The larger the spheres and balls, and the greater the distances separating them (compatible with the power of the induction coil), the higher is the potential of the sparks and the greater the oscillations to which they give rise, and consequently the greater the distance at which they are perceptible. The balls *a b* are connected each to one end of the secondary coil of the Ruhmkorff apparatus B. The primary wire of the induction coil is excited by the battery *c*, thrown in and out of circuit by the key *k*. The efficiency of the sending apparatus depends greatly on the power and constancy of the induction coil: thus a coil yielding a 6-inch spark will be effective up to three or four miles; but for greater distances than this more powerful coils, as one emitting 10-inch sparks, must be used.<sup>2</sup>

The various parts of the sending apparatus are generally so constructed and adjusted as to emit per second about 250 million waves of about 1.3 metres long.

At the receiving station *n* (fig. 38) is Marconi's special form of the Branly-Lodge detector, shown full size in fig. 39. This is the part which gave him the most trouble. While

<sup>1</sup> Mr Marconi's later experience has led him to doubt these advantages, and to discard the use of oil. He now uses simply a single spark-gap between two balls, as *a b* in fig. 37. See 'Jour. Inst. Elec. Engs.,' No. 139, p. 311, or p. 282 *infra*.

<sup>2</sup> But there is a limit: powerful induction coils of the Ruhmkorff kind are difficult to make and keep in order, and do not by reason of their residual magnetism admit of the very rapid make-and-break action required. Doubtless other and more effective means of excitement will soon be discovered, as Tesla's oscillators, or by the use of Wehnelt's electrolytic contact-breaker, which can be made to interrupt a current one thousand times and more per second. See 'Jour. Inst. Elec. Engs.,' No. 131, p. 317.

for laboratory experiments any detector sufficed to give indications on a sensitive mirror galvanometer at a distance of a few yards, Mr Marconi had to seek a thoroughly practical and reliable arrangement which could stand the comparatively rough usage of everyday work, be restorable to its

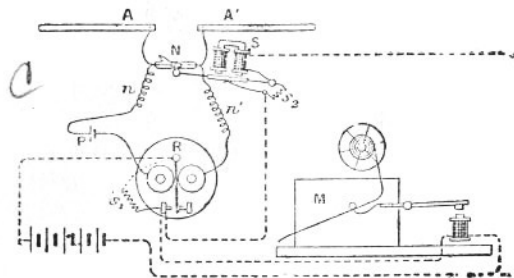

Fig. 38.

normal condition (after every wave) with the utmost certainty, and, at the same time, be sufficiently responsive to the very feeble waves which are found at a great distance from the source, so as to allow of the passage of a current strong enough to actuate a telegraph relay. His detector consists

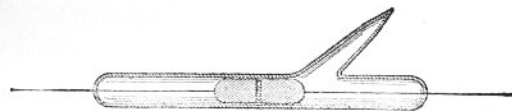

Fig. 39.

of a glass tube, 4 centimetres long and 2.5 millimetres interior diameter, into which two silver pole-pieces, 1 millimetre apart, are tightly fitted, so as to prevent any scattering of the powder. The small intervening space is filled with a mixture of 96 parts of nickel and 4 of silver, not too finely powdered, and worked up with a trace of mercury.

By increasing the proportion of silver powder the sensitiveness of the detector is increased *pro rata*; but it is better for ordinary work not to have too great sensitiveness, as the detector then too readily responds to atmospheric electricity and other stray currents. Similarly, the smaller the powder space the more sensitive is the instrument; but if too small, the action is capricious. The quantity of powder required is, of course, very small, but it must be treated with care: it must neither be too compressed nor too loose. If too tight the action is irregular, and often the particles will not return to their normal condition, or "decohere," as Lodge expresses it; if too loose coherence is slight, and the instrument is not sufficiently sensitive. The best adjustment is obtained when the detector works well under the action of the sparks from a small electric trembler at one metre's distance. The tube is then hermetically sealed, having been previously exhausted of air to about  $\frac{1}{1000}$ th of an atmosphere. This, though not essential, is desirable, as it prevents the oxidation of the powder.

In its normal condition the metallic powder, as already stated, is practically a non-conductor, offering many megohms resistance. The particles (to use Preece's expressive words) lie higgledy-piggledy, anyhow, in disorder. They lightly touch each other in a chaotic manner; but when electric waves fall upon them they are polarised—order is installed—they are marshalled in serried ranks and press on each other,—in a word, they cohere, electrical continuity is established, and a current passes, the resistance falling from practical insulation to a few ohms or a few hundred ohms according to the energy of the received impacts. Usually it ranges from 100 to 500 ohms.<sup>1</sup>

<sup>1</sup> The action of the detector is hardly yet understood, but recent investigations of Arons (Broca, 'Télégraphie sans Fils,' Paris, 1899, p. 117), of Sundorph ('Science Abstracts,' No. 23, p. 757), and of

The detector is included in the circuit of two electromagnetic impedance or choking coils  $n n'$ , a local battery of one or two Leclanché cells  $p$ , and a fairly sensitive polarised relay as ordinarily used in telegraphy  $R$ . The impedance or choking coils, consisting of a few turns of insulated copper wire on a glass tube, containing an iron bar 5 or 6 centimetres long, are intended to prevent the electric energy escaping through the relay circuit. Prof. Silvanus Thompson doubts the efficacy of this contrivance, but Mr Marconi's experience shows its great utility. Thus, when the coils are removed, all other things remaining the same, the signalling distance is reduced by nearly one-half.

$A A'$  are resonance plates or wings (copper strips) whose dimensions must be adjusted so as to bring the detector into tune electrically with the exciter.

The relay actuates two local circuits on the parallel or shunt system, one containing an ordinary Morse instrument  $M$ , and the other the tapper  $s$ . The relay and tapper are provided with small shunt coils  $s_1$  and  $s_2$  to prevent sparking at the contacts, which would otherwise impair the good working of the detector. The Morse instrument and the tapper may also be connected in series in one circuit, in which case the former may be made to act as a buzzer, the signals being read by sound. Indeed, the Morse machine may be left out altogether and the signals be read from the sound of the tapper alone. The printing lever of the Morse is so adjusted—an easy matter—as not to follow the rapid makes and breaks of the local current caused by the action of the tapper. Consequently, although the current in the

Tommasina ('Electrician,' vol. xlv. p. 213) seem to bear out the view adopted in the text. Compare Prof. Lodge's views *re* coherence in his 'Work of Hertz,' pp. 22, 70. Also Lamotte's excellent article on "Cohéreurs ou Radioconducteurs," 'L'Éclairage Électrique,' Paris, March 31, 1900.

coils of the Morse is rapidly discontinuous, the lever remains down (and prints) so long as the detector is influenced by the waves sent out by the exciter. In this way the lever gives an exact reproduction of the movements of the distant sending key, dots and dashes at the key coming out as dots and dashes in the Morse. The speed at which signalling can be carried on is but little slower than that in ordinary (Morse) telegraphy, fifteen words a minute being easily attained.

In practice, the sending part of the apparatus should be screened as much as possible by interposed metal plates from the receiving instruments, so as to prevent local inductive interferences; or better, the detector may be shut up in a metal box.

This arrangement is effective for short distances, up to two miles, with clear open spaces, especially if metallic reflectors are erected behind the exciter and detector, and carefully focussed so as to throw the electric rays in the right direction. But for long distances, and where obstacles intervene, as trees, houses, hills—in fact, for practical purposes—certain modifications are necessary which are shown in fig. 40. Reflectors are discarded which are troublesome and expensive to make and difficult to adjust. One knob of the exciter is connected to a stout insulated copper wire, led to the top of a mast and terminating in a square sheet or a cylinder of zinc, which Marconi calls a "capacity area." For still greater distances the wire may be flown from a kite or balloon<sup>1</sup> covered with tinfoil.

<sup>1</sup> In a recent popular lecture it is seriously stated that, when kites are used to carry the conductors, "the electricity obtained from the air, when they were flown high enough, was sufficient to enable the operator to do away with a primary battery" ! ('Electrical Engineer,' October 1, 1897). This is the Mahlon Loomis idea *redivivus* (see p. 68 *supra*), and is as true as another "vulgar error"—to wit, that Marconi, and now Tesla, can explode torpedoes and powder-magazines

The other knob of the exciter is connected to a good earth.

The exciting apparatus is adapted and adjusted for the emission into space of much longer waves than those mentioned on page 208. The wave-length is determined by the height of the vertical wire, being approximately equal to

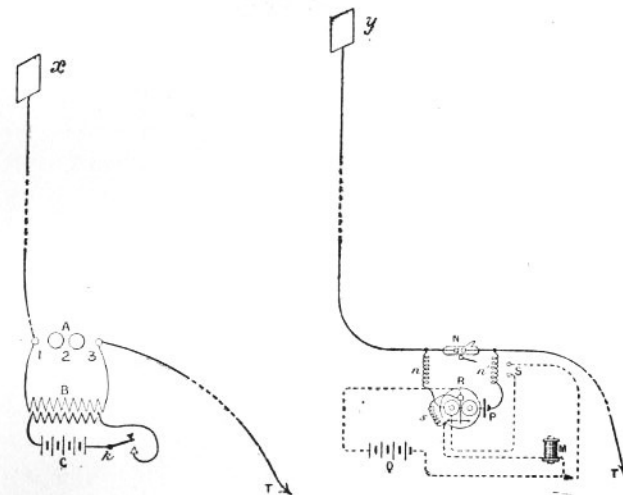

Fig. 40.

four times the height, so that in long-distance signalling the Marconi waves may be many hundreds of feet long.

At the receiving station the resonance wings of the detector are discarded, and one side is connected to a vertical wire and the other side to earth, as in the case of the exciter. Of course, in practice only one vertical wire is required at

at their own sweet will. This, of course, might be done, if they could plant a properly adjusted exploding apparatus near the powder; but if they could do this, they could, as Preece says, do many other funny things.

each station, as by means of a switch it can be connected with the exciter for sending, or with the detector for receiving, as may be necessary. The parallelism of the wires and plates,  $x$  and  $y$ , should be preserved as much as possible in order to obtain the best effects.

The *raison d'être* of the earth connections is not yet clearly understood. An earth wire on the exciter for long distances is essential, but at the detector it may apparently be dispensed with without any (appreciable) effect.<sup>1</sup>

However this may be, an earth wire (and a good one too) should be used on the detector as well as on the exciter, if only as a protection from lightning. The vertical wire is practically a lightning-catcher, and the detector is an excellent lightning-guard when connected to earth. But if disconnected from earth, and lightning strikes the wire, then we may expect all the disastrous results which follow from a badly constructed or defective lightning-protector. The fear, then, that the Marconi apparatus is especially dangerous may be put aside. Being an excellent lightning-conductor and lightning-guard in one, it may, in my opinion, be safely used, even in a powder-magazine.

From a long series of experiments in Italy in 1895 Mr Marconi worked out a law of distance which all his later experience seems to verify. "The results," he says, "showed that the distance at which signals could be obtained varied approximately as the square of the height of the capacity areas from earth, or, perhaps, as the square of the length of the vertical conductors. This law furnishes us with a safe means of calculating what length the vertical wire should be in order to obtain results at a given distance. The law has never failed to give the expected results across clear space in any installation I have carried out, although it usually seems that the distance actually obtained is slightly

<sup>1</sup> 'Jour. Inst. Elec. Engs.,' No. 137, pp. 801, 802, 900, 918, 946, 962.

in excess. I find that, with parity of other conditions, vertical wires 20 feet long are sufficient for communicating one mile, 40 feet four miles, 80 feet sixteen miles, and so on.

"Professor Ascoli has confirmed this law, and demonstrated mathematically, using Neumann's formula, that the action is directly proportional to the square of the length of one of the two conductors if the two are vertical and of equal length,<sup>1</sup> and in simple inverse proportion to the distance between them. Therefore the intensity of the received oscillation does not diminish with the increase of distance if the length of the vertical conductors is increased in proportion, or as the square root of the distance."<sup>2</sup>

Delicate as the apparatus undoubtedly is, and complicated as it may seem, its action is simplicity itself to the telegraphist, differing only in the kind of electricity and the medium of communication from that of the everyday telegraph. On depressing the key  $k$  (fig. 40) to make, say, a dash, induced currents are set up in the secondary coil of the Ruhmkorff machine; the vertical wire is thereby "charged" up to such a point that it "discharges" itself in sparks across the gaps 1, 2, and 3, and this charging and discharging goes on with extreme rapidity. The wire thus becomes the seat of a rapidly alternating or oscillating current, which gives rise to an equally rapid oscillatory disturbance of the ether all round the wire. These ether oscillations are the Hertzian waves, and

<sup>1</sup> If of unequal lengths then the action is proportional to the product of the two lengths, which, however, must not be too dissimilar. Thus, in the recent American Navy trials, signals from a torpedo-boat with 45 feet of vertical wire to a warship with 140 feet of wire were read at a distance of eighty-five miles; but *vice versa*, from the higher sending to the lower receiving wire, signalling was only practicable over seven miles. See p. 243 *infra*.

<sup>2</sup> Recent experience goes to show that there is no such simple law. Greater distances are now worked over with shorter wires than formerly.

they spread out into space, much as water waves do when a stone is thrown into a pond, or as air waves do when a sound or a musical note is struck. On arriving at the receiving station these Hertzian, or, as they are also called, electro-magnetic waves, enfeebled more or less as the distance is great or small, strike the wire  $y$ , and generate along it an oscillatory current of the same kind (though, of course, weaker) as that along the wire  $x$ . This results in what I may call invisible sparks across the detector gap, which break down the insulation resistance of the contained powder and make it conductive, thus allowing the local battery to act; the relay thereupon closes, and the Morse instrument sounds, or prints the signal as may be required, the tapper all the while doing its work of decohering.

This account of what occurs on depressing the key must be considered as popular rather than as scientifically accurate, for I do not think we yet know what actually takes place, or precisely how it takes place. It must also be confessed that the Marconi apparatus itself is still in the empirical stage, and many questions connected with its distinctive features and their interdependence have yet to be solved. For instance, is the Marconi effect under all circumstances truly Hertzian and oscillatory? Some authorities seem to think that it is one of electro-static, others of electro-magnetic, induction. Again, do the waves radiating from the sending station always travel in rectilinear lines, or are they susceptible of deflection by intervening masses of earth and water? To obtain the best effects, the elevated wires must be vertical as regards the earth, and parallel to each other; but how can they be both in the case of great distances where the curvature of the earth comes into play? Are the capacity areas  $x$  and  $y$  necessary? Some say no; others, and amongst them Mr Marconi, say yes, but only for short distances. Then again, assuming

that true Hertzian waves are radiated from  $x$  and arrive at  $y$ , how do the feeble invisible sparks (so to speak) which they evoke at the detector gap act upon the filings so as to make them conductive? Why is it that transmission is practicable to greater distances over sea than over land? Why is a thick vertical wire better for use with the exciter, and a thin wire for use with the detector? Finally, why is it (apparently) immaterial whether or not we use an earth connection on the detector? These are some of the questions awaiting solution; but if I may hazard an opinion, I would say that when solved we shall find that after all the Marconi effect is but on a large scale a Leyden jar effect, complicated no doubt, but still such as every schoolboy is familiar with in principle, and that it conforms to the same laws and conditions.

Marconi's first trials on a small scale were made at Bologna, and these proving successful he came to England and applied for a patent, June 2, 1896.<sup>1</sup> Soon after, in July, he submitted his plans to the postal-telegraph authorities, and, to his honour be it said, they were unhesitatingly—even eagerly—taken up by Preece, although, as we have already seen, he was introducing a method of his own.

The first experiments in England were from a room in the General Post Office, London, to an impromptu station on the roof, over 100 yards distant, with several walls, &c., intervening. Then, a little later, trials were made over Salisbury Plain for a clear open distance of nearly two miles. In these experiments roughly-made copper parabolic reflectors were employed, with resonance plates on each side of the detector (see figs. 36, 38).

<sup>1</sup> This being the first patent of the *New Telegraphy* order, is historically interesting. I have therefore thought it convenient to reproduce it in Appendix E, with the original rough drawings.

In May 1897 still more extensive trials were made across the Bristol Channel between Lavernock and Flat Holm, 3·3 miles, and between Lavernock and Brean Down, near Weston-super-Mare, 8·7 miles (see fig. 20, *supra*). Here the reflectors and resonance plates were discarded. Earth and vertical air wires were employed, as in fig. 40, the vertical wires being in the first case 50 yards high, while in the second case kites carrying the wires were had recourse to.

The receiving apparatus was at first set up on the cliff at Lavernock Point, about 20 yards above sea-level. Here was erected a pole, 30 yards high, on the top of which was a cylindrical cap of zinc, 2 yards long and 1 yard diameter. Connected with this cap was an insulated copper wire leading to one side of the detector, the other side of which was connected to a wire led down the cliff and dipping into the sea. At Flat Holm the sending apparatus was arranged, the Ruhmkorff coil used giving 20-inch sparks with an eight-cell battery.

On the 10th May experiments on Preece's electro-magnetic method (already fully described) were repeated, and with perfect success.

The next few days were eventful ones in the history of Mr Marconi. On the 11th and 12th his experiments were unsatisfactory—worse, they were failures—and the fate of the new system trembled in the balance. An inspiration saved it. On the 13th the receiving apparatus was carried down to the beach at the foot of the cliff, and connected by another 20 yards of wire to the pole above, thus making a height of 50 yards in all. Result, magic! The instruments, which for two days failed to record anything intelligible, now rang out the signals clear and unmistakable, and all by the addition of a few yards of wire! Thus often, as Carlyle says, do mighty events turn on a straw.

Prof. Slaby of Charlottenberg, who assisted at these ex-

periments, has told us in a few graphic words the feelings of those engaged. "It will be for me," he says, "an ineffaceable recollection. Five of us stood round the apparatus in a wooden shed as a shelter from the gale, with eyes and ears directed towards the instruments with an attention which was almost painful, and waited for the hoisting of a flag, which was the signal that all was ready. Instantaneously we heard the first *tic tac, tic tac*, and saw the Morse instrument print the signals which came to us silently and invisibly from the island rock, whose contour was scarcely visible to the naked eye—came to us dancing on that unknown and mysterious agent the ether!"

After this the further experiments passed off with scarcely a hitch, and on the following day communication was established between Lavernock and Brean Down.

The next important trials were carried out at Spezia, by request of the Italian Government, between July 10 and 18, 1897. The first three days were taken up with experiments between two land stations 3·6 kilometres apart, which were perfectly successful. On the 14th, the sending apparatus being at the arsenal of San Bartolomeo, the receiving instruments were placed on board a tug vessel, moored at various distances from the shore. The shore wire was 26 metres high, and could be increased to 34 if necessary; the tug wire was carried to the top of the mast, and was 16 metres high. The results were unsatisfactory: signals came, but they were jumbled up with other weird signals, which came from the atmosphere (the weather was stormy) in the way which telegraph and telephone operators know so well. On the 15th and 16th (the weather having moderated) better results were obtained, and communication was kept up at distances up to 7·5 kilometres.

On the 17th and 18th the receiving apparatus was transferred to a warship (ironclad), and, with a shore elevation of



34 metres and a ship elevation of 22 metres, signals were good at all distances up to 12 kilometres, and fairly so at 16 kilometres.

During these experiments it was observed that whenever the funnels, iron masts, and wire ropes of the vessels were in line with the shore apparatus the detector did not work properly, which was to be expected from the screening property of metals; but another and more serious difficulty was also encountered. When the vessel got behind a point of the land which cut off the view of the shore station, the signals came capriciously, and good working was not established until the shore was again in full view. Here was a difficulty which must be surmounted if the new system was to be of any practical utility. We have seen in our account of the work of Hertz that electric waves pass without appreciable hindrance through doors and walls and, generally, non-conducting bodies, being only arrested by metals and other conductors; but in practice, when we come to deal with doors and walls in large masses—as trees, buildings, hills—they seem to partake of the nature of metals, and largely absorb the waves, just as light passes through a thin sheet of glass but is arrested by a thick sheet.

This is one of the vexed questions connected with the theory of the Marconi telegraph. In the early days intervening obstacles certainly did interfere with correct signalling, and in some cases they do so still.<sup>1</sup> Yet in many of Marconi's later trials he appears to have found no difficulty. At the Isle of Wight a hill 300 feet higher than his vertical wires has proved no obstacle.

In the experiments at Dover during the last British Association meeting (August 1899) the great mass of the

<sup>1</sup> 'Jour. Inst. Elec. Engs.,' No. 139, pp. 295, 305, 315; 'Science Abstracts,' No. 15, p. 214, and No. 24, p. 878; 'Electrician,' vol. xlv. pp. 140, 212.

Castle Rock, 400 feet high, did not seem to interfere with the signalling between Dover Town Hall and the South Foreland lighthouse, four miles distant, or the Goodwin lightship, twelve miles farther off. Again, between the Town Hall and Wimereux, across Channel, a mass of houses, tall buildings, and overhead tramway wires appeared to have no bad effect.<sup>1</sup>

Better proof still, we learn that during the same experiments the Wimereux signals intended for Dover were received at the Marconi factory at Chelmsford, eighty-five miles distant from the French station, and that, in fact, signalling was carried on between those two places.<sup>2</sup>

During the naval manœuvres last summer (1899) off Bantry, messages were correctly exchanged between ships when a hill over 800 feet high intervened; and, again, between the Europa and Juno, when eighty-five miles apart, and with thirty ironclads, &c. (with all their masses of metal, funnels, iron masts, and wire rigging), manœuvring in between. The vertical wire on each ship was 170 feet high, so that, owing to the curvature of the earth, a hill of water must have intervened, through or round which the electric waves must have travelled—but which?

According to the observations of Le Bon,<sup>3</sup> they must have gone round it. The length, he says, of the Hertzian waves enables them to turn round obstacles with facility, even metallic bodies in certain circumstances—a fact which accounts for the, apparently, partial transparency of metallic mirrors. "Non-metallic bodies," he goes on to say, "have been considered to be perfectly transparent to Hertzian waves, but do these waves go through a hill or round it? 12 centimetres of Portland cement are only partially

<sup>1</sup> 'Electrician,' vol. xliii. pp. 737, 768.

<sup>2</sup> 'Electrician,' vol. xliii. p. 816.

<sup>3</sup> 'Science Abstracts,' No. 22, p. 671.

transparent, while 30 centimetres are non-transparent or wholly opaque. Dry sand is almost entirely transparent, but wet sand much less so—that is, is partially opaque. Freestone is more transparent than cement, but increases in opacity as it becomes wet. Generally speaking, the transparency of non-metallic bodies varies for each substance and decreases as the thickness and humidity of the body increase." If this be so, the Hertzian waves which act upon a detector on the other side of a hill must go over and round the hill, not through it, just as they go round the edges of metallic mirrors, or travel over the bent or looped wire in some experiments of Hertz and Lodge.

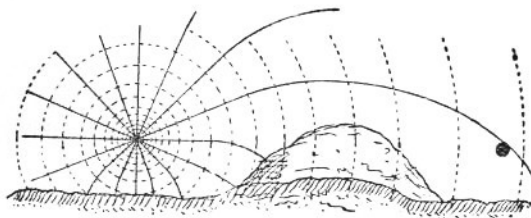

Fig. 41.

This is also the conclusion at which Sir William Preece,<sup>1</sup> Mr Marconi himself,<sup>2</sup> and other authorities have arrived. When, says the former, the ether is entangled in matter of different degrees of inductivity, the lines of force are curved, as in fact they are in light. Fig. 41, which I borrow from Preece, shows how, according to his view, hills are bridged over.

On the other hand, Prof. Branly, while maintaining the theory that electric waves travel in straight lines only, has thrown out the suggestion that the opacity or otherwise

<sup>1</sup> Lecture, Royal Institution, June 4, 1897.

<sup>2</sup> Lecture, Royal Institution, February 2, 1900. Compare his view in 'Jour. Inst. Elec. Engs.,' March 2, 1899.

of intervening bodies may be only a question of wave-lengths—that such bodies may be opaque to some waves, and transparent or partially so to others. Referring to the proposal for firing submarine mines from a distance by means of electric waves, he says, "The thing can only be done if water is transparent to the waves used. The fact that a sheet of tinfoil is capable of completely intercepting electric waves, would make us think that the opacity of water, and especially of salt water, is very probable. He tested various liquids and solutions experimentally, and found that a layer of tap water, 20 centimetres thick, suffices to reduce the signalling distance to one-fifth of its value in open air. The same thickness of salt water intercepts the waves completely. Mineral oil is no more absorptive than air itself. Sea salt is particularly absorptive—more so than the sulphates of zinc, sodium, and copper. The result is therefore fatal to the use of electric waves across intervening water; but it is just possible that the wave-length used may make some difference. Waves from a 2-cm. spark are completely intercepted, while those from a 20-cm. Righi spark are transmitted to the extent of about  $\frac{1}{2}$  per cent by sea water 20 cm. thick. It should be remembered that sea water is largely transparent to electric waves of the length of light waves [Röntgen waves], and it is just possible that there are other regions of non-absorption in the electric spectrum."<sup>1</sup>

Whatever the explanation may be, the fact remains that intervening masses do reduce the distance over which a given power and adjustment of apparatus can work, and that their effect is greater over land than over sea—by about one-third. When therefore it is said that interposed bodies offer no difficulty, it should be understood that they offer no difficulty that is not surmountable, and

<sup>1</sup> 'Comptes Rendus,' October 1899, quoted in the 'Electrician,' vol. xlv. p. 140.

we may suppose that the loss is in practice compensated for in one or both of the following ways: (1) by increasing the height of the vertical wires, and so increasing the length of the wave and the volume of the ether disturbed at the sending station; and (2) by increasing the power of the sending and the sensitiveness of the receiving apparatus. But we speedily reach a limit in these directions, so that as far as one can see at present the effective distance of the Marconi system must be small compared with the older methods of telegraphy by wire.

Of course, if ever required, means of automatically repeating the signals could be devised, although there would be great practical difficulties attending the use of the metallic screens which would have to be employed. Another young Italian, Mr Guarini-Foresio, is now working in this direction.<sup>1</sup>

On his return to Germany after witnessing the Marconi trials in England, Prof. Slaby in September 1897 engaged in some very instructive experiments in the vicinity of Potsdam, first between Matrosenstation and the church at Sacrow, 1.6 kilometre, and then between the former place and the castle of Pfaueninsel, 3.1 kilometres. I take the following particulars from the 'Electrical Engineer,' December 3, 1897:—

Prof. Slaby recently, at a technical college in Berlin, gave an interesting report of his experiments on telegraphy without wires, or, as he wants it to be called, "spark telegraphy." He mentioned an experiment made by himself by which he was able to send by means of one wire two different messages simultaneously without interfering with each other. He explained that the continuous current used in ordinary telegraphy is conducted along the middle of the wire, and he

<sup>1</sup> See his *brochure*, 'Transmission de L'Électricité sans Fil,' 2nd edition, p. 29 *et seq.*; or 'Electrical Review,' November 10, 1899.

proved that electric waves on their way through the ether are attracted by wires which come in their way, and that they travel along the outside of those wires without influencing the interior. In making use of these observations he succeeded in sending a wave message along the outside of the wire while another message was proceeding through the centre by the continuous current.

Prof. Slaby says that, in conjunction with Dr Dietz, he made many experiments with "spark telegraphy" before Marconi's inventions became known, but did not achieve any important results.<sup>1</sup>

After his return, however, from England he experimented still further. The Emperor of Germany was present at some of these experiments, and put a number of sailors and the large royal gardens at Potsdam at his disposal. The receiver was erected at the naval station and the transmitter on Peacock Island. The first experiments gave no result, because the coherers used were a great deal too sensitive, and contained, among other things, too much silver, and were affected by the electricity in the atmosphere, and in consequence were constantly affected even when no signals were sent from the sending station.

<sup>1</sup> Referring to these experiments in his book, 'Die Funkentelegraphie,' Berlin, 1897, Prof. Slaby handsomely acknowledges Marconi's merits in the following words: "Like many others, I also had taken up this study, but never got beyond the limits of our High School. Even with the aid of parabolic reflectors and great capacity of apparatus I could not attain any further. Marconi has made a discovery. He worked with means the full importance of which had not been recognised, and which alone explain the secret of his success. I ought to have said this at the commencement of my subject, as latterly, especially in the English technical press, the novelty of Marconi's process was denied. The production of the Hertzian waves, their radiation through space, the sensitiveness of the electric eye, all were known. Very good; but with these means 50 metres were attained, but no more."

Further experiments showed that the results increased in the same measure as the sensitiveness of the coherer decreased. Prof. Slaby uses now very rough and jagged nickel filings which have been carefully cleaned and dried. As the receiving station could not be seen from the island, the sending station was removed to a church a little farther away, and the exciter was put between the columns of the portico, while the mast which carried the wire was erected on the spire. The experiments then went very well.

When the sending apparatus was put back a little farther into the church, and the wire was put for about a length of 2 yards parallel with the stone slabs of the floor and a yard and a half above it, it ceased to work properly, because the waves seek the earth. Hence one must not bring the wire too near to the earth, or lay it parallel when near the earth. When the sending apparatus was moved back to the island, it was found that trees near the wire proved an obstacle because they received the waves. Therefore the Professor says that it is best to so arrange that the wires on the receiver and on the transmitter can be seen from each other. Even the sail of a little boat or the smoke from a steamer cause small interruptions, which make the signals more or less indistinct. The waves get through impedimenta, and even through buildings, but there is always much loss. In order to make the wire which was placed on the island more visible from the mainland, it was lengthened from 25 to 65 yards, and placed upon a boat on the river. That did not remedy matters; but when the wire on the receiver was also lengthened to 65 yards very good results followed, showing that the length of the wire is of great importance.

Prof. Slaby next proceeded, early in October, to experiment over an open stretch of country, free from all intervening obstacles, between Rangsdorf (sending station) and

Schöneberg (receiving station), a distance of 21 kilometres. Captive balloons raised to a height of 300 metres were employed. On the first two days the results were disappointing, and the fault was found to be in the vertical conductors, which consisted of the wire cables holding the balloons. With a double telephone wire there was a slight improvement; and eventually, on the 7th October, "fine insulated copper wire of .46 millimetres diameter was substituted with excellent results."

Correspondence was now always good, except when disturbed by atmospheric discharges (the weather being stormy). At such times the signals were distorted and confused, and often the discharges were so strong as to unpleasantly shock the operators, making it necessary to handle the apparatus with the greatest care.<sup>1</sup> Here is another serious difficulty with which Mr Marconi has to contend, and from which we see no escape short of total suspension of operations during stormy weather—namely, the great liability to accident and derangement, not merely from lightning flashes, to which all telegraph systems are subject, but from all those other electrical disturbances of the atmosphere which have hitherto been of little account. The greater the distance worked over, the higher must be the conductors, and, consequently, the greater must be the danger.

The apparatus used by Prof. Slaby differed somewhat from Marconi's, the following being the more important points:—

1. A Weston galvanometer relay, which, it is curious to note, is our old friend in modern guise, the Wilkins' relay, used by Mr Wilkins in his wireless telegraph experiments in 1845 (see p. 39, *supra*).

<sup>1</sup> See also Brett's remarks, 'Jour. Inst. Elec. Engs.,' No. 137, p. 945; and Preece, 'Jour. Soc. Arts,' vol. xlvii. p. 522.

2. An ordinary Branly-Lodge detector with hard nickel powder only.
3. No impedence or "choking" coils.<sup>1</sup>

The further course of Marconi's experiments is so succinctly given by the chairman of the Wireless Telegraph Company in a recent address, October 7, 1898, that we cannot do better than follow him.<sup>2</sup>

"A year ago," he says, "when this company was started (July 1897), Mr Marconi happened to be in Italy making experiments for the Italian Government, and for the King and Queen at the Quirinal. On his return to this country, the first long-distance trial was made between Bath and Salisbury. The receiver in this case was given to a post-office official, who went to Bath and by himself rigged up a station, at which he received signals thirty-four miles distant from where they were sent at Salisbury. After this we put a permanent station at Alum Bay, Isle of Wight. This station at first was used in connection with a small steamer that cruised about in the neighbourhood of Bournemouth, Boscombe, Poole Bay, and Swanage, a distance of eighteen miles from the Needles Hotel station, with which it was in constant telegraphic communication.

"Various exhibitions were given later—one at the House of Commons, where a station was erected, and another station at St Thomas's Hospital opposite (May 1898). Within an hour of the time our assistants arrived to put up the installation, the system was at work. We had many exhibitions at our offices, at which a number of people

<sup>1</sup> About this time Dr Tuma of Vienna was engaged on similar experiments, using, however, instead of a Ruhmkorff coil a Tesla oscillator or exciter, with nickel powder only in the detector. I have not seen any detailed account of these experiments.

<sup>2</sup> I have incorporated a few passages from Mr Marconi's recent paper (Institution of Electrical Engineers, March 2, 1899), so as to make the account more complete. These are shown in brackets thus [ ].

attended; amongst others Mr Brinton, a director of the Donald Currie line of steamers, who asked if we could report a ship passing our station. This was done. The ship was the Carisbrooke Castle, on her first voyage out, and as she passed the Needles a message reporting the fact was wirelessly telegraphed to Bournemouth, and there put on the ordinary telegraph wires for transmission to Mr Brinton.

"After this Lord Kelvin visited our station at Alum Bay, and expressed himself highly pleased with all he saw. He sent several telegrams, *via* Bournemouth, to his friends, for each of which he insisted on paying one shilling royalty, wishing in this way to show his appreciation of the system and to illustrate its fitness for commercial uses. The following day the Italian Ambassador visited the station. Among other messages, he sent a long telegram addressed to the Aide-de-camp to the King of Italy. As it was in Italian, and as Mr Marconi's assistant at Bournemouth had no knowledge of that language, it may be taken as a severe test—as, in fact, a code message. The telegram was received exactly as it was sent. Previously, we had a display for the 'Electrical Review' and the 'Times,' both of which papers sent representatives. They put the system to every possible test, and, among others, sent a long code message, which had to be repeated back. In their reports they stated that this was done exactly as sent.

[In May Lloyd's desired to have an illustration of the possibility of signalling between Ballycastle and Rathlin Island in the north of Ireland. The distance between the two positions is seven and a half miles, of which about four are overland and the remainder across the sea, a high cliff also intervening between the two positions. At Ballycastle a pole 70 feet high was used to support the wire, and at Rathlin a vertical conductor was supported by the light-

house 80 feet high. Signalling was found quite possible between the two points, but it was thought desirable to bring the height of the pole at Ballycastle to 100 feet, as the proximity of the lighthouse to the wire at Rathlin seemed to diminish the effectiveness of that station. At Rathlin we found that the lighthouse-keepers were not long in learning how to work the instruments, and after the sad accident which happened to poor Mr Glanville, that installation was worked by them alone, there being no expert on the island at the time.<sup>1</sup>

“Following this, in July last (1898) we were requested by a Dublin paper, the ‘Daily Express,’ to report the Kingstown regatta. In order to do this we erected a [land] station at Kingstown, and another on board a steamer which followed the yachts. A telephone wire connected the Kingstown station with the ‘Daily Express’ offices, and as the messages came from the ship they were telephoned to Dublin and published in successive editions of the evening papers.<sup>2</sup>

[After the races longer distances were tried, and it was found that with a height of 80 feet on the ship and 110 feet on land it was possible to communicate up to a distance of twenty-five miles; and it is worthy of note in this case that the curvature of the earth intervened very considerably at such a distance between the two positions.]

“After this, Mr Marconi was requested to put up a station at Osborne to connect with the Prince of Wales’ yacht Osborne. Bulletins of the Prince’s health (his Royal Highness, as we all know, met with a lamentable accident just

<sup>1</sup> Mr Glanville, a promising young electrician (only twenty-five years old), was missing from Saturday to the Tuesday evening following, when his body, terribly mutilated, was found at the foot of a cliff 300 feet high in Rathlin Island.

<sup>2</sup> Very full illustrated accounts of this remarkable experiment are given in the Dublin ‘Mail,’ July 20, 21, and 22, 1898.

before then) were reported to her Majesty: not only that, but the royalties made great use of our system during the Cowes week.

[In this installation induction-coils capable of giving a 10-inch spark were used at both stations. The height of the pole supporting the vertical conductor was 100 feet at Osborne House. On the yacht the top of the conductor was attached to the mainmast at a height of 83 feet from the deck, thus being very near one of the funnels, and in the proximity of a great number of wire stays. The vertical conductor consisted of a  $\frac{7}{16}$  stranded wire at each station. The yacht was usually moored in Cowes Bay at a distance of nearly two miles from Osborne House, the two positions not being in sight of each other, the hills behind East Cowes intervening.]

[On August 12 the Osborne steamed to the Needles and communication was kept up with Osborne House until off Newton Bay, a distance of seven miles, the two positions being completely screened from each other by the hills lying between. From the same position we found it quite possible to speak with our station at Alum Bay, although Headon Hill, Golden Hill, and over five miles of land lay directly between. Headon Hill was 45 feet higher than the top of our wire at Alum Bay, and 314 feet higher than the wire on the yacht.]

“Within the last few days we have had to move our station at Bournemouth four miles farther west, where we have put up the same instruments, the same pole, and everything at the Haven Hotel, Poole, which is eighteen miles from Alum Bay. This increase of distance has no detrimental effect on our work; in fact it seems rather easier, if anything, to receive signals at the Haven Hotel than at our former station: thus, the height of the conductor at Bournemouth was 150 feet,

but this is now reduced to 100 feet, which is a very great improvement.<sup>1</sup>

[The vertical conductors are stranded  $\frac{7}{16}$  copper wire insulated with india-rubber and tape. A 10-inch spark induction coil is used at each station, worked by a battery of 100 Obach cells M size, the current taken by the coil being 14 volts of from 6 to 9 ampères. The sparks take place between two small spheres about 1 inch diameter, this form of transmitter having been found more simple and more effective than the Righi exciter previously used. The length of spark is adjusted to about 1 centimetre, which, being much shorter than the coil can give, allows a large margin for any irregularity that may occur. No care is now taken to polish the spheres at the place where the sparks occur, as working seems better with dull spheres than with polished ones.]

“The Marconi invention is the only (electric) telegraph by means of which a moving object can be kept in communication with any other moving object, or a fixed station, and therefore any one can see the great use of the invention, not only to the Royal Naval authorities, but also to the mercantile marine. A ship fitted with Mr Marconi's apparatus can not only keep in telegraphic communication with the shore up to any reasonable distance—it has been thoroughly tested up to twenty-five miles off the shore—but ships can also, if properly equipped, be warned of approaching danger or their proximity to dangerous coasts which are fitted with the wireless apparatus.

[If we imagine a lighthouse provided with a transmitter constantly giving an intermittent series of electric waves, and a ship provided with a receiving apparatus placed in the focal line of a reflector, it is plain that when the

<sup>1</sup> The height has since been gradually reduced to 75 feet.

receiver comes within the range of the transmitter the bell will be rung only when the reflector is directed towards the transmitter. If, then, the reflector is caused to revolve by clockwork or by hand, it will give warning only when occupying a certain sector of the circle in which it revolves. It is therefore easy for a ship in a fog to make out the exact direction of the lighthouse, and, by the conventional number of taps or rings corresponding to the waves emitted, she will be able to discern, either a dangerous point to be avoided, or the port for which she is endeavouring to steer.<sup>1</sup>

[In December of last year the Company thought it desirable to demonstrate that the system was available for telegraphic communication between lightships and the shore. This, as you are aware, is a matter of much importance, as all other systems tried so far have failed, and the cables by which ships are connected are exceedingly expensive, and require special moorings and fittings, which are troublesome to maintain and liable to break in storms. The officials of Trinity House offered us the opportunity of demonstrating to them the utility of the system between the South Fore-

<sup>1</sup> Theoretically this is possible, but practically I fear the size and management of the reflector would make it very difficult. A simpler way *might* be by reverting to the original form of the apparatus (p. 206 *supra*), and by revolving a cylindrical metallic screen (with a longitudinal slit or opening not too wide) around the detector until the position is found in which the bell rings under the influence of the electric rays entering at the opening. Even here I foresee difficulties. However, the thing is easily put to actual test, and, considering its great importance, I am surprised that this has not been done.

Bela Schäfer in Austria, and Russo d'Asar in Italy, are said to be able to determine the presence and course of a ship at 60 to 80 kilometres distant. If this has been done, then, *vice versa*, a ship should be able to determine the presence and direction of a lighthouse.

land Lighthouse and one of the following light-vessels—viz., the Gull, the South Goodwin, and the East Goodwin. We naturally chose the one farthest away—the East Goodwin—which is just twelve miles from the South Foreland Lighthouse.

[The apparatus was taken on board in an open boat and rigged up in one afternoon. The installation started working from the very first, December 24, without the slightest difficulty. The system has continued to work admirably through all the storms, which during this year have been remarkable for their continuance and severity. On one occasion, during a big gale in January last, a very heavy sea struck the ship, carrying part of her bulwarks away. The report of this mishap was promptly telegraphed to the superintendent of Trinity House, with all details of the damage sustained.

[The height of the wire on board the ship is 80 feet, the mast being for 60 feet of its length of iron, and the remainder of wood. The aerial wire is led down among a great number of metal stays and chains, which do not appear to have any detrimental effect on the strength of the signals. The instruments are placed in the aft-cabin, and the aerial wire comes through the framework of a skylight, from which it is insulated by means of a rubber pipe. As usual, a 10-inch coil is used, worked by a battery of dry cells, the current taken being about 6 to 8 ampères at 14 volts.

[The instruments at the South Foreland Lighthouse are similar to those used on the ship; but as we contemplate making some long-distance tests from the South Foreland to the coast of France, the height of the pole is much greater than would be necessary for the lightship installation alone.]

These tests were duly carried out, and on March 27,

1899, communication was successfully established between England and France.<sup>1</sup>

“On this side of the Channel,” says the ‘Daily Graphic’ (March 30, 1899), “the operations took place, by permission of the Trinity House, in a little room in the front part of the engine-house from which the power is derived for the South Foreland lighthouses. The house is on the top of the cliffs overlooking the Channel. The demonstrations are being conducted for the benefit of the French Government, who have the system under observation, and besides Signor Marconi there were present at the Foreland yesterday Colonel Comte du Bontavice de Heussey, French Military Attaché in England; Captain Ferrie, representing the French Government; and Captain Fieron, French Naval Attaché in England. During the afternoon a great number of messages in French and English crossed and recrossed between the little room at the South Foreland and the Châlet D’Artois, at Wimereux, near Boulogne.

“The whole of the apparatus stood upon a small table about 3 feet square, in the centre of the room. Underneath the table the space was fitted with about fifty primary cells; a 10-inch induction coil occupied the centre of the table. The spark is 1½ centimetre long, or about three-quarters of an inch; the pole off the top of which the current went into space is 150 feet high. The length of spark and power of current were the same as used for communication with the East Goodwin lightship, a fact which seems remarkable when it is considered that the distance over which the messages were sent yesterday was nearly three times as great. The greater distance is compensated for by the increased height of the pole.

“Throughout the whole of the messages sent yesterday

<sup>1</sup> All the London daily papers of March 29 and 30 contain full and glowing accounts of this installation.



there was not once a fault to be detected—everything was clearly and easily recorded. The rate of transmission was about fifteen words a minute.”

The first international press message sent by the new system was secured by the ‘Times,’ and is as follows:—

“(From our *Boulogne Correspondent.*)

“WIMEREUX, *March 28.*

“Communication between England and the Continent was set up yesterday morning by the Marconi system of wireless telegraphy. The points between which the experiments are being conducted are South Foreland and Wimereux, a village on the French coast two miles north of Boulogne, where a vertical standard wire, 150 feet high, has been set up. The distance is thirty-two miles. The experiments are being carried on in the Morse code. Signor Marconi is here conducting the trials, and is very well satisfied with the results obtained.

“This message has been transmitted by the Marconi system from Wimereux to the Foreland.”

Amongst the experts in electrical science who witnessed these experiments was Prof. Fleming, F.R.S., of University College, London, who has given us his impressions in a long letter to the ‘Times’ (April 3, 1899). He tells us that throughout the period of his visit messages, signals, congratulations, and jokes were freely exchanged between the operators sitting on either side of the Channel, and automatically printed down in telegraphic code signals on the ordinary paper slip at the rate of twelve to eighteen words a minute. Not once was there the slightest difficulty or delay in obtaining an instant reply to a signal sent. No familiarity with the subject removes the feeling of vague wonder with which one sees a telegraphic instrument merely

connected with a length of 150 feet of copper wire run up the side of a flagstaff begin to draw its message out of space and print down in dot and dash on the paper tape the intelligence ferried across thirty miles of water by the mysterious ether.

An extensive trial of the system between ships at sea was next made during the British naval manœuvres in July 1899. Three ships of the B fleet were fitted up—the flagship, *Alexandra*, and the cruisers, *Juno* and *Europa*. The greatest distance to which signals were sent

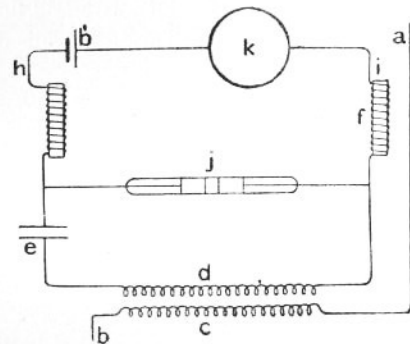

Fig. 41A.

was sixty nautical miles between the *Juno* and *Europa*, and forty nautical miles between the *Juno* and *Alexandra*. These were not the maximum ranges attained, but the distances at which, under all circumstances, the system could be relied on for certain and accurate transmission. Test signals were obtainable up to a distance of seventy-four nautical miles (eighty-five miles).

These important results were obtained by the use of Marconi's peculiar form of induction coil or transformer.<sup>1</sup>

<sup>1</sup> Then just patented. See his specification, No. 12,326, of June 1, 1898 (accepted July 1, 1899); or abstract in ‘*Electrician*,’ vol. xliii. p. 847.

Fig. 41A shows the arrangement, where  $a$  is the vertical wire,  $b$  the earth connection,  $c$  the primary and  $d$  the secondary wires of the transformer, and  $e$  a condenser. "The object of this arrangement," says Mr Marconi, "is to increase the electromotive force of the oscillations at the terminals of the detector  $j$ , and therefore to cause its state of insulation to break down with weaker oscillations, and so be affected at a much greater distance than is possible when the detector is connected directly with the vertical wire." The primary coil is wound with fine wire (contrary to the usual practice), and the secondary with still finer wire.

In his first experiments with transformer coils of various

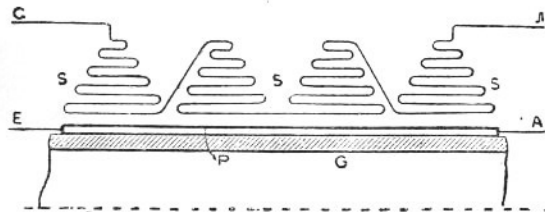

Fig. 41B.

kinds, Marconi found that if the secondary wire be wound in more than one layer, little if any advantage is obtained. He was led to try a mode of winding in which the centre of the coil still consisted of a single layer, but with the number of turns increased at the ends. This gave much better results, and led, finally, to the arrangement shown in fig. 41B, which "represents an enlarged half-longitudinal section of the coil, but is not drawn strictly to scale. Also, instead of showing the section of each layer of wire as a longitudinal row of dots or small circles, as it should appear, it is for simplicity drawn as a single continuous line." It will thus be seen that the secondary wire is wound curiously in four sections; and another peculiarity is that these

sections must be connected together in the way shown, and, as the distance from the primary wire increases, the number of turns in each section must decrease.

The use of these small coils during the naval manœuvres had a very marked effect on the detector, enabling it to respond to waves from greater distances. Thus, when working between the Juno and Europa with a given power in the transmitter and height of vertical wires, the effective signalling distance was seven nautical miles without the coil, and sixty nautical miles with it.<sup>1</sup>

After the naval manœuvres Marconi stations were opened at Chelmsford and Harwich, forty miles apart; and in August (1899), during the meetings of the British Association at Dover and the French Association at Boulogne, messages were freely exchanged between the two places, the distance across Channel being about thirty miles. Correspondence was also kept up between Dover and the South Foreland (four miles) and the Goodwin (sixteen miles) stations across the great masses of the Castle Rock (400 feet high) and the South Foreland cliffs. Communication was also found possible between Wimereux and Chelmsford or Harwich. The distance in each of these cases is about eighty-five miles, of which thirty are over sea and fifty-five over land. The height of the vertical wires at each end was 150 feet, thus showing, and confirming the results of many previous experiments, that considerable masses of intervening rock, earth, and water do not offer an insurmountable obstacle to the transmission of signals. If they did, and if it had been necessary for a line drawn between the tops of the wires to clear the curvature of the earth,

<sup>1</sup> 'Electrician,' vol. xlv. p. 555. Prof. Fessenden, in America, uses in the same way a specially constructed transformer which is reported to be many times more effective than Marconi's ('Electrician,' vol. xliii. p. 807), and with which "it should be possible to signal across the Atlantic with 200 feet vertical wires" ('Globe,' January 1, 1900.)

they would have had to be in this case over 1000 feet high.

In America, October 1899, the Marconi apparatus was employed to report from sea the progress of the yachts in the international contest between the Columbia and the Shamrock. The working was (of course) perfectly satisfactory, and as many as 4000 words are said to have been transmitted in one day from the (two) ship stations to the shore station.<sup>2</sup>

Immediately after the races the instruments were placed, by request, at the service of the American Navy Board, who put them to some severe and interesting tests. The cruiser, New York, and the battleship, Massachusetts, were equipped under Mr Marconi's personal supervision. The two vessels lay at anchor in the North River, 480 yards apart, or about the distance that would separate ships steaming in squadron formation. The signalling operations on the New York were performed by Mr Marconi himself, aided by an assistant, and under the directions of two members of the Navy Board; while the signalling on the Massachusetts was done by one of Marconi's assistants, under the inspection of another navy official. The object of the first experiments was to determine the practicability of the system for short-distance signalling between squadrons at sea. The first test was the sending and receiving of a newspaper article of about 1500 words, which was done without error, and at a speed of eleven words per minute. The second test was the transmission of a series of numbers of various lengths, which was also done correctly, and with a little more rapidity. The third test dealt with a series of letters written down at random; the fourth, a series of short messages; and the fifth and sixth, series of code-word

<sup>1</sup> 'Electrician,' vol. xliii. pp. 737, 768, 793, 816; vol. xliv. p. 557.

<sup>2</sup> 'New York Herald' (Paris edition), October 6, 1899.

messages. These latter naturally taxed the skill of the operators, the "words" having a weird look, unpronounceable, and with absolutely no sense or meaning. It is therefore not surprising that in these tests one or two errors were detected; but they were probably as much the fault of the operator as of the apparatus. Indeed, as Mr Marconi has pointed out, all these experiments were more tests of the operators for correctness and speed of signalling than of the utility of the apparatus, which for such short distances was incontestable.

The vessels then left for the open sea. At a point about five miles off the Highlands the New York anchored, while the Massachusetts continued on her course, exchanging signals with her consort at intervals of ten minutes. Up to some distance short of thirty-six miles the signals were good, but what that distance was the report from which we are quoting does not specify; it merely says, "At a distance of thirty-six miles the messages failed to carry, and the battleship came back and anchored a few hundred yards from the New York."<sup>1</sup>

In order to test the possibility of interference with the signals, a Marconi apparatus was established at the Highlands, with a vertical wire of 150 feet. At intervals during the time that messages were being exchanged between the two warships the Highlands station sent out other signals, with the invariable result that the correspondence between the ships was rendered unintelligible.<sup>2</sup>

The official report of such an independent authority as the American Navy Board must always be valuable; and as, moreover, it contains precise information on other points

<sup>1</sup> In an article in the 'Times,' November 16, 1899, the effective distance is said to have been thirty-five miles, and that the apparatus was only designed to carry thirty miles, that being considered the outside range requisite for the yacht-reporting operations.

<sup>2</sup> 'Electrician,' vol. xliv. p. 106.

not referred to in the preceding paragraphs, I think it useful to reproduce it as follows:—

“We respectfully submit the following findings as the result of our investigation of the Marconi system of wireless telegraphy: It is well adapted for use in squadron signalling under conditions of rain, fog, and darkness. Wind, rain, fog, and other conditions of weather do not affect the transmission; but dampness may reduce the range, rapidity, and accuracy by impairing the insulation of the aerial wire and the instruments. Darkness has no effect. We have no data as to the effects of rolling and pitching; but excessive vibration at high speed apparently produced no bad effect on the instruments, and we believe the working of the system would be very little affected by the motion of the ship. The accuracy is good within the working ranges. Cipher and important signals may be repeated back to the sending station, if necessary, to ensure absolute accuracy. When ships are close together (less than 400 yards) adjustments, easily made, of the instruments are necessary. The greatest distance that messages were exchanged with the station at Navesink was  $16\frac{1}{2}$  miles. This distance was exceeded considerably during the yacht races, when a more efficient set of instruments was installed there.<sup>1</sup> The best location of instruments would be below, well protected, in easy communication with the commanding officer. The spark of the sending coil, or of a considerable leak, due to faulty insulation of the sending wire, would be sufficient to ignite an inflammable mixture of gas or other easily lighted matter, but with direct lead (through air space, if possible) and the high insulation necessary for good work no danger of fire need be apprehended. When two

<sup>1</sup> This is a mistake. The instruments were the same in both cases. See ‘Times’ article, November 16, 1899.

transmitters are sending at the same time, all the receiving wires within range receive the impulses, and the tapes, although unreadable, show unmistakably that such double sending is taking place. In every case, under a great number of varied conditions, the interference was complete. Mr Marconi, although he stated to the Board before these attempts were made that he could prevent interference, never explained how, nor made any attempt to demonstrate that it could be done. Between large ships (heights of masts 130 feet and 140 feet) and a torpedo-boat (height of mast 45 feet), across open water, signals can be read up to seven miles on the torpedo-boat and eighty-five miles on the ship. Communication might be interrupted altogether when tall buildings of iron framing intervene. The rapidity is not greater than twelve words per minute for skilled operators. The shock from the sending coil of wire may be quite severe, and even dangerous to a person with a weak heart. No fatal accidents have been recorded. The liability to accident from lightning has not been ascertained. The sending apparatus and wire would injuriously affect the compass if placed near it. The exact distance is not known, and should be determined by experiment. The system is adapted for use on all vessels of the navy, including torpedo-boats and small vessels, as patrols, scouts, and despatch boats, but it is impracticable in a small boat. For landing-parties the only feasible method of use would be to erect a pole on shore and thence communicate with the ship. The system could be adapted to the telegraphic determination of differences of longitude in surveying. The Board respectfully recommends that the system be given a trial in the navy.”<sup>1</sup>

On Mr Marconi's return voyage from America he gave an interesting demonstration of the value of his system for

<sup>1</sup> ‘Electrician,’ vol. xlv. p. 212.

ships at sea. "A few days previous," he says, "to my departure, the war in South Africa broke out. Some of the officials of the American liner suggested that, as a permanent installation existed at the Needles, Isle of Wight, it would be a great thing, if possible, to obtain the latest war news before our arrival at Southampton. I readily consented to fit up my instruments on the *St Paul*, and succeeded in calling up the Needles station at a distance of sixty-six nautical miles, when all the important news was received on board, the ship the while steaming her twenty knots per hour. The news was collected and printed in a small paper, called the 'Transatlantic Times,' several hours before our arrival at Southampton."<sup>1</sup>

In October 1899 the War Office sent out some Marconi instruments to South Africa, for use at the base and on the railways; but the military authorities on the spot realised that the system could only be of value at the front, and the apparatus was moved up to the camp at De Aar. The results at first were not altogether satisfactory, a fact which is accounted for by the absence of suitable poles or kites; and afterwards, when kites were improvised, the wind was so variable that it often happened that when the kite was flying at one station there was a calm at the other station. However, when suitable kites were obtained, and the wind was favourable, communication was possible from De Aar to the Orange River, or about seventy miles. Stations were subsequently established at Belmont, Enslin, and Modder river on the west, and in Natal on the east. No reliable reports of the work of these installations

<sup>1</sup> 'Electrician,' vol. xlv. p. 557. Also the 'Times,' November 16 and 18, 1899. This unique production was printed by the ship's compositor, and published at a dollar per copy, the proceeds going to the Seamen's Fund. The 'Times' of November 16 reproduces the contents.

amongst the South African kopjes have yet reached us, but we hope, with Mr Marconi, that "before the campaign is ended wireless telegraphy will have proved its utility in actual warfare."<sup>1</sup>

Having now brought my account of the more important of Marconi's public demonstrations up to date,<sup>2</sup> I propose to occupy a few final pages with some further remarks on the theory and practice of Hertzian-wave telegraphy.

It has been objected to the Marconi system that, with the removal of the reflectors and the resonance wings, the condition of privacy in telegrams is no longer possible, since any one provided with the necessary apparatus can receive the signals at any point within the circle of which the sending station is the centre and the receiving station the radius. Another, and in some cases more serious, objection is that any one by erecting a wire or wires in the vicinity of a Marconi station can propagate therefrom Hertzian waves, which by interference will so confuse the effects in the detector as to make correct signalling impracticable. It may not even be necessary to propagate counter-waves: a large sheet of metal (or several such sheets) erected high in air, in line with the stations, at right angles to the direction of the waves, and connected by a wire to the earth, will intercept much of the energy, and the more so as it is near to either of the stations. Thus, if used for naval or

<sup>1</sup> 'Electrician,' vol. xlv. p. 557. Up to date (January 1901) we have no authentic accounts of the results obtained, although the Marconi staff have long ago returned to England. Rumour says the kopjes have proved too difficult. See, however, Major Flood Page's remarks, 'Electrician,' March 2, 1900.

<sup>2</sup> Of course I do not pretend that these are the only demonstrations of value that have been made. In America, France, Germany, and Italy, and doubtless in other countries, important experiments have been and are being made; but beyond occasional brief notices of them in the newspapers, and still fewer notices in the technical journals, few clear and veracious accounts have come under my notice.

military purposes, an enemy could either tap the dispatches or render them unintelligible at pleasure. The latter objection is from the nature of things unavoidable, and in practice must limit the application of the system to lines of communication sufficiently apart as not to interfere with one another. The first objection, however, can be obviated to some extent by reverting to the condition of syntony or resonance with reflectors, and it is in this direction that improvements may soon be expected.

Dr Oliver Lodge, F.R.S., the distinguished Professor of Physics, University College, Liverpool, and the coadjutor and expounder of Hertz in England, has long been engaged on the problem of a Hertzian-wave telegraph—especially with a view of securing syntony in the sending and receiving apparatus, and thereby limiting the communications to similarly attuned instruments, the absence of which selective character is at present one of the great drawbacks of the Marconi system.

We have seen (p. 204, *supra*) that as early as June 1, 1894, Prof. Lodge had exhibited apparatus which was effective for signalling on a small scale, but, as he says, "stupidly enough no attempt was then made to apply any but the feeblest power, so as to test how far the disturbance could really be detected. . . . There remained, no doubt, a number of points of detail, and considerable improvements in construction, if the method was ever to become practically useful."<sup>1</sup> These he has since worked out, and some of them are embodied in his patent, No. 11,575, of May 10, 1897, "Improvements in Syntonised Telegraphy without Line Wires."

As capacity areas, spheres or square plates of metal may be employed; but for the purpose of combining low resistance with large electro-static capacity, cones or triangles are

<sup>1</sup> 'The Work of Hertz,' pp. 67, 68.

preferred, with the vertices adjoining and their larger areas spreading out into space. Or a single insulated surface may be used in conjunction with the earth—the earth, or conductors embedded in it, constituting the other capacity area. As radiation from these surfaces is greater in the equatorial than in the axial direction, so, when signalling in all directions is desired, the axis of the emitter should be vertical. Moreover, radiation in a horizontal plane is less likely to

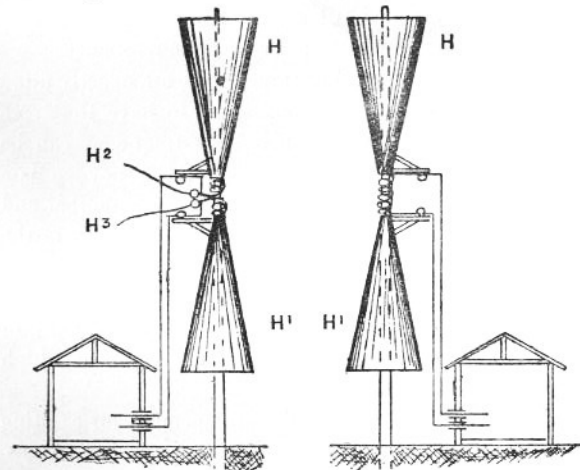

Fig. 42.

be absorbed during its passage over partially conducting earth or water.

Fig. 42 shows the arrangement for long-distance signalling.  $H H^1$  are large triangular sheets of metal, which by means of suitable switches (not shown) can be connected to the sending or the receiving apparatus as desired. Those on the left-hand side of the figure are shown in connection with polished knobs  $H^2 H^3$  (protected by glass from ultraviolet light), which form the adjustable spark-gap of the

exciter. Between each capacity area and its knob is inserted a self-inductance coil of thick wire or metallic ribbon (see  $H^4$ , fig. 43) suitably insulated, the object of which is to prolong the electrical oscillations in a succession of waves, and thereby obtain a definite frequency or pitch, rendering syntony possible, since exactitude of working depends on the fact that with the emission of a number of successive waves the feeble impulse at the receiving station is gradually strengthened till it causes a perceptible effect, on the well-known principle of sympathetic resonance.

The capacity areas and inductance coils are exactly alike at the two communicating stations, so as to have the same frequency of electrical vibration. This frequency can be altered either by varying the capacity of the Leyden jars used in the exciting circuit, or by varying the number and position of the inductance coils, or by varying both in the proper degree, thus permitting only those stations whose rate of oscillation is the same to correspond.

To actuate the exciter a Ruhmkorff coil may be used, or a Tesla coil, a Wimshurst machine, or any other high tension apparatus.

Fig. 43 shows the details of the arrangement for exciting and detecting the electric waves. When used as a transmitter the receiving circuit is disconnected from the capacity areas by a suitable switch (not shown). Let us first consider the arrangement as a transmitter. Putting the Ruhmkorff coil  $A$  in action, it charges the Leyden jars  $J J$ , whose outer coatings are connected, first, through a self-inductance coil  $H^5$  of fairly thin wire, so as to permit of thorough charging of the jars; and, second, to the "supply gaps"  $H^6 H^7$ . When the jars are fully charged to sparking-point, sparks occur at the "starting-gap"  $H^8$ . These precipitate sparks at the "supply gaps," which evoke electrical charges in the capacity areas  $H H^1$ . These charges surge through the inductance coils  $H^4$ , and spark into each other across

the "discharge gap" between the knobs  $H^2 H^3$ . This last discharge, according to Prof. Lodge, is the chief agent in starting the oscillations which are the cause of the emitted waves; but it is permissible to close the "discharge gap," and so leave the oscillations to be started by the sparks at the "supply gaps" only, whose knobs must then be polished and protected from ultra-violet light, "so as to supply the electric charge in as sudden a manner as possible."

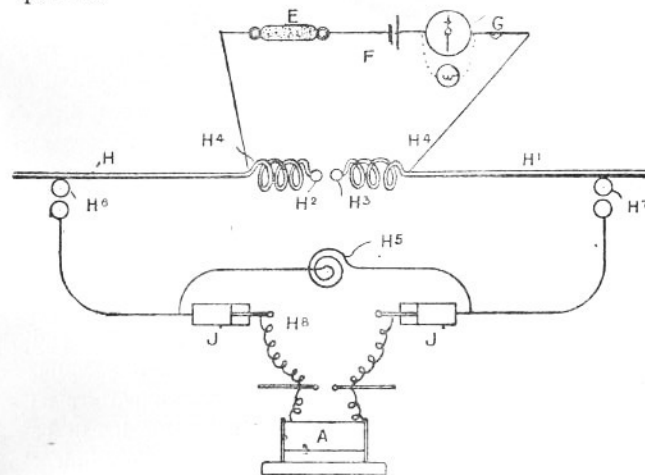

Fig. 43.

When used as a receiver the "discharge-gap" is bridged over by a suitable cut-out, and connection is made with the receiving circuit, as shown on the top of fig. 43. As detector, Lodge uses—

1. His own original form of coherer, fig. 44, wherein a metallic point  $x$  rests lightly on a flat metallic surface  $o$  (for instance, a needle point of steel or platinum making light contact with a steel or aluminium bar like a watch spring), fixed at one end  $p$ , and delicately adjustable by a

micrometer screw *Q*, so as to regulate the pressure at the point *N*. Or—

2. A Branly tube filled with selected iron filings of uniform size, sealed up in a good vacuum, and with the

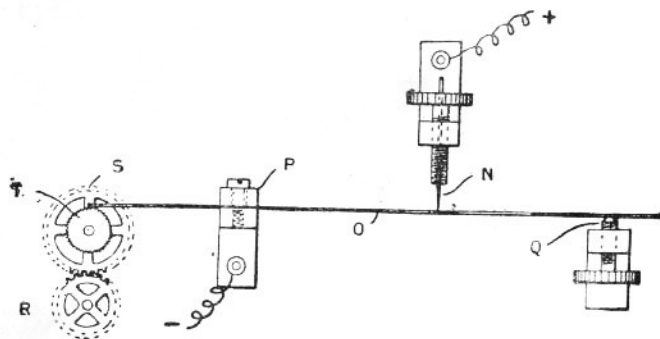

Fig. 44.

electrodes, which are of platinum, reduced to points a short distance apart.

His latest form of the Branly coherer is shown full size in fig. 45, and is said to be exceedingly sensitive and certain in its action, especially in a very high vacuum. *A* is a glass tube held tightly by ebonite supports *B B*; *C* is a pocket or reservoir for spare filings, which can be added to, or taken from, the effective portion as required by inverting the tube; *D D* are the silver electrodes immersed in the filings, which are, as before, of carefully selected iron of uniform size as nearly as possible; *E* is one of the terminals of the silver electrodes, the other of which is hidden from view.

The instrument is secured by the clamp screw *F* to any convenient support, to which the tapping or decohering apparatus is applied.<sup>1</sup>

<sup>1</sup> It appears that to Professor Blondel is due the credit of first constructing a coherer of this kind in August 1898. See the 'Electrician,' vol. xliii. p. 277.

When an electric wave from a distant exciter arrives and stimulates electric vibrations in the syntonised capacity areas, the electrical resistance of the coherer suddenly and greatly falls and permits the small battery *F*, fig. 43, to actuate a relay *G*, or a telephone, or other telegraphic instrument.

To break contact, or to restore the original great resistance of the coherer, any form of mechanical vibration suffices, as a clock, or a tuning-fork, or a cog-wheel (as in fig. 44), or other device for causing a shake or tremor, and kept in motion by a spring, or weight, or by electrical means. Indeed, the mere motion of any clockwork attached to the coherer stand will suffice, an exceedingly slight, almost imperceptible, tremor being all that is usually required.

Usually the coherer is arranged in simple series with the battery and telegraphic instrument, and is so joined to the capacity areas as to include in its circuit the self-inductance coils—an arrangement which Prof. Lodge considers of great advantage, or, as he says, "an improvement on any mode of connection that had previously been possible without these coils."

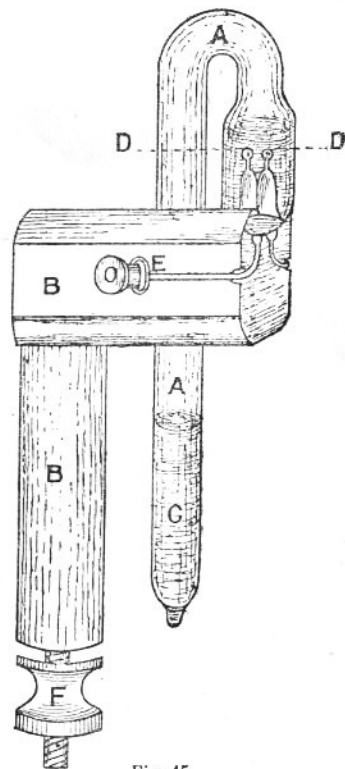

Fig. 45.



The patent specification figures and describes another way—viz., enclosing the inductance coils in an outer or secondary coil (constituting a species of transformer), and making this coil part of the coherer circuit. In this case the coherer is stimulated by the waves in the secondary coil instead of, as before, by those in the inductance coils, which with their capacity areas are thus left free to vibrate without disturbance from attached wires.

In all cases it is permissible, and sometimes desirable, to shunt the coils of the telegraphic instrument  $G$  by means of a fine wire or other non-inductive resistance coil  $w$ , "in order to connect the coherer more effectively and closely to the capacity areas."

At the Royal Society Conversazione on May 11, 1898, a complete set of Lodge's apparatus was shown in action, in which certain modifications in the signalling and recording parts were introduced at the suggestion of Dr Alexander Muirhead. Instead of the ordinary Morse key, Muirhead's well-known automatic transmitter with punched tape was employed at one end of the suite of rooms, and a siphon-recorder as the receiving instrument at the other end. The recorder was so arranged as to print, not as usually zigzag traces, but (the needle working between stops) a momentary deflection mark for a dot and a longer continued mark for a dash.

The siphon-recorder is so quick in its responses that it indicates each one of the group of sparks emitted from the sending apparatus: hence a dash is not merely a deflection held over, but is made up of a series of minute vibrations; and even a dot is seen to consist of similar vibrations, though of course of a lesser number. If the speed of signalling is slow and the recorder tape moves slowly, these vibrations appear as actual dots and dashes; but each signal, when examined with a microscope, is seen to consist of a short or long series of lines representing the constituent vibrations.

At a slow rate of working the signals can thus be got with exceeding clearness; but for actual signalling this is not at all necessary, and it is possible to attain a high speed, making such brief contacts that a single deflection of the recorder needle indicates a dot, and three consecutive deflections a dash. The paper thus marked does not look like the ordinary record, but more resembles the original Morse characters as depicted on pp. 404 and 409 of Shaffner's 'Telegraph Manual' (New York, 1859), and is easily legible with a little practice.

An ordinary telephone was also available as a receiver (connected through a transformer coil) in which the dots and dashes were heard very clearly and distinctly.

The apparatus is reported to have worked well (except at the high speeds, when it occasionally missed fire), and did not seem to be in the least affected by any of the numerous electrical exhibits in the neighbourhood, although some of them must have set up considerable radiation of Hertzian waves.

Based on the same principles—viz., the emission of electric waves at one place and their detection by some form of coherer at another place—there is naturally a similarity in the outlines of the Lodge system and that of Marconi for short distances (where vertical wires are not used), as depicted in fig. 38, *supra*. The differences are differences of arrangement and detail only, but they appear to be fraught with some important consequences.

In the first place, Prof. Lodge claims that his arrangement of the sending apparatus is a more persistent exciter, in that it emits a longer train of longer waves,<sup>1</sup> which by acting cumulatively on the detector breaks down its insulation, when more powerful but fewer trains of shorter waves might be inoperative. Then in the next place, this

<sup>1</sup> For some important observations on this point see Mr A. Campbell Swinton, 'Jour. Inst. Elec. Engs.,' No. 139, p. 317.

element of persistency permits of the use of syntonising contrivances, by means of which the rate of oscillation of any desired set of instruments can be accurately attuned so that only those instruments can correspond, without affecting or being affected by other sets tuned to a different frequency, thus securing to some extent the advantage of privacy in the communications.

Lodge's arrangement has worked well in the laboratory and lecture-room, but he does not appear to have tried it (which is a pity) over any considerable distance, so that it remains to be seen how far he can go without having recourse to vertical wires, which Marconi finds so essential for practical work over distances of more than two or three miles.<sup>1</sup>

Speaking of the waste of energy all round a Marconi transmitter as now constructed, and of the desirability of preventing it if possible, a writer in a recent volume of the 'Electrician' (vol. xli. p. 83) has some remarks which may appropriately be given here. "Unless," he says, "some means are adopted for converging the radiation along a definite path, the practical and commercial efficiency of Hertzian-wave telegraphy will be small, and the enormous quantities of wasted radiation spreading away from the line of signalling will have to be prevented from interfering with other receiving stations. Prof. Lodge has proposed the syntonising of instruments as a means of preventing this interference, and it is undoubtedly possible to tune the receiver so that it will respond only to waves of a particular pitch; but should wireless telegraphy by Hertzian waves ever become extensively practised over considerable distances, the number of possible non-interfering tones of wave-lengths will be found insufficient for the number of receiving stations. Besides, the syntonising method of confining the message to its proper path has the disadvan-

<sup>1</sup> For Professor Lodge's newest developments see his paper, 'Jour. Inst. Elec. Engs.,' No. 137, p. 799, which deserves careful study.

tage that it does not confine the energy to that path; it is therefore very wasteful.

"Hertzian waves, like their natural relatives light waves, have the property that they can be reflected and refracted; though, from the fact of their much greater wave-length, the apparatus requisite for converging them in a parallel beam is more difficult to construct and more costly than is, for example, the parabolic reflector of a search light or the compound lens of a lighthouse. Nevertheless there are well-known substances, of which pitch is an example, which, when formed into a lens or prism, have the power of acting upon Hertzian waves precisely as lenses or prisms of glass act upon rays of ordinary light. As a scientific fact this has been known since Hertz's time, but there would appear to be considerable difficulty in its application.

"We are inclined to think, however, that it will ultimately be found necessary to employ, in wireless telegraphy, some such means as a huge pitch lens would afford for collecting the scattering rays from the Hertzian wave generator or oscillator, and refracting them into a beam of almost, if not quite, parallel rays; thus improving, both in efficiency and in penetrative power, this interesting method of propagating signals through space."

Mr Marconi has been steadily working at these problems of syntonisation and reflection. The latter is, I fear, only possible for short distances, up to a few miles, and with apparatus as originally constructed (p. 206, *ante*). For greater distances necessitating considerable lengths of vertical wire such huge reflectors would be required, and their adjustment would be so difficult as to make the plan practically impossible.

From syntonising methods some promising results have been obtained. In a recent letter to the 'Times' (October 4, 1900) Prof. Fleming has some startling revelations. "For the last two years," he says, "Mr Marconi has not

ceased to grapple with the problem of isolating the lines of communication, and success has now rewarded his skill and industry. Technical details must be left to be described by him later on, but meanwhile I may say that he has modified his receiving and transmitting appliances so that they will only respond to each other when properly tuned to sympathy.

“These experiments have been conducted between two stations 30 miles apart—one near Poole in Dorset and the other near St Catherine’s in the Isle of Wight. At the present moment there are established at these places Mr Marconi’s latest appliances, so adjusted that each receiver at one station responds only to its corresponding transmitter at the other. During a three days’ visit to Poole, Mr Marconi invited me to apply any test I pleased to satisfy myself of the complete independence of the circuits, and the following are two out of many such tests: Two operators at St Catherine’s were instructed to send simultaneously two different wireless messages to Poole, and without delay or mistake the two were correctly recorded and printed down at the same time in Morse signals on the tapes of the two corresponding receivers at Poole.

“In this first demonstration each receiver was connected to its own independent aerial wire hung from the same mast. But greater wonders followed. Mr Marconi placed the receivers at Poole one on the top of the other, and connected them both to one and the same wire, about 40 feet in length, attached to a mast. I then asked to have two messages sent at the same moment by the operators at St Catherine’s, one in English and the other in French. Without failure each receiver at Poole rolled out its paper tape, the message in English perfect on one and that in French on the other. When it is realised that these visible dots and dashes are the results of trains of intermingled electric

waves rushing with the speed of light across the intervening 30 miles, caught on one and the same short aerial wire, and disentangled and sorted out automatically by the two machines into intelligible messages in different languages, the wonder of it all cannot but strike the mind.

“Your space is too valuable to be encroached upon by further details, or else I might mention some marvellous results, exhibited by Mr Marconi during the same demonstrations, of messages received from a transmitter 30 miles away and recorded by an instrument in a closed room merely by the aid of a zinc cylinder, 4 feet high, placed on a chair. More surprising is it to learn that, whilst these experiments have been proceeding between Poole and St Catherine’s, others have been taking place for the Admiralty between Portsmouth and Portland, these lines of communication intersecting each other; yet so perfect is the independence that nothing done on one circuit now affects the other, unless desired. A corollary of these latest improvements is that the necessity for very high masts is abolished. Mr Marconi now has established perfect independent wireless telegraphic communication between Poole and St Catherine’s, a distance of 30 miles, by means of a pair of metal cylinders elevated 25 feet or 30 feet above the ground at each place.”

If these latest improvements yield only one-half of the results indicated by Prof. Fleming, the value of Marconi’s system will be enormously enhanced and its sphere of utility correspondingly extended.<sup>1</sup> We therefore await with impatience the promised disclosures as to how all these wonderful things can be done.

Even should the improvements turn out to be of no great practical value, or to be not susceptible of extensive applica-

<sup>1</sup> In which case we shall have, in future editions, to withdraw or at least to modify some of our remarks as to its present limitations.

tion, we can well be content with the system as described in these pages. It has proved to be practical up to sixty or seventy miles, and within this limit there ought to be a wide and useful field for activity. Thus, many outlying islands are within this distance from each other and from the continents, with which communication at *all* times has hitherto been practicable only by the use of cables, which are always costly to make and lay, and often costly to keep in repair. Here, especially between places where the traffic is not great, is a large field to be occupied as cables grow old and fail.

Then, we have seen from the address of the chairman of the Wireless Telegraph Company that negotiations are going on with Lloyd's which, if carried into practical effect, will result in an extensive application for signalling between Lloyd's stations and outward and inward bound vessels passing in their vicinity. Indeed it is not rash to predict that the lighthouses and lightships around the coasts, not only of the British Isles but of all countries, will in time be supplied with wireless telegraphs, keeping up constant correspondence with all who go down to the sea in ships. Then, again, there is the application to intercommunication between ships at sea. Ships carrying the Marconi apparatus can carry on a definite conversation with the occupants of lighthouses and lightships and with each other. It will readily be seen that this might, in many cases, be far more serviceable than the few light signals now obtainable, or the signalling by flags, horns, &c.—a tedious process at best, and one that is often full of uncertainty, if not of positive error.<sup>1</sup>

<sup>1</sup> The English, American, German, and French naval authorities are now making independent experiments with the Marconi system, and it is probable we may soon hear of its adoption, or of some modification of it, as part of the equipment of not only warships but of all large vessels.

Turning from sea to land, we find, for the reasons we have already indicated, a more circumscribed field of application—at all events, until means are devised for focusing the electric rays and rendering the apparatus syntonie. But even then, although by these means we will be able to record messages only where intended, there still remain cross interferences of which I fear we can never be rid, and therefore we can never use the system in a network of lines as now, where wires cross, recross, and overlap each other in all ways and directions. The various waves of electricity would so interfere with each other in their effects on the detectors that the result would be chaos. Therefore wireless telegraphy can only be used in lines removed from each other's disturbing influences, as in sparsely populated countries and undeveloped regions.

However, many cases of impromptu means of communication arise where, as Prof. Lodge says, it might be advantageous to "shout" the message, spreading it broadcast to receivers in all directions, and for which the wireless system is well adapted, seeing that it is so inexpensive and so easily and rapidly installed,—such as for army manoeuvres, for reporting races and other sporting events, and, generally, for all important matters occurring beyond the range of the permanent lines.

But for the regular daily correspondence of a nation with its lines ramifying in all directions and carrying enormous traffics, the Marconi system is not adapted, no more than any other wireless method that has been proposed, or is likely to be invented in our day. So, for a long time to come we must keep to our present telegraphic and telephonic wires, using the wireless telegraph as an adjunct for special cases and contingencies such as I have mentioned.

A few words as to the future, by way of conclusion, and

our task is completed. On this point we find some recent remarks of Prof. Silvanus Thompson so appropriate that we quote them in full, as being more authoritative than anything we could ourselves say. Prof. Thompson has thoroughly studied the subject, and therefore "speaks by the card."

"It has been shown," he says, "that there are three general methods of transmitting electric signals across space. All of them require base lines or base areas. The first—conduction—requires moist earth or water as a medium, and is for distances under three miles the most effective of the three. The second—induction—is not dependent upon earth or water, but will equally well cross air or dry rock. The third—electric wave propagation—requires no medium beyond that of the ether of space, but is interfered with by interposed things such as masts or trees. Given proper base lines or base areas, given adequate methods of throwing electric energy into the transmitting system, and sufficiently sensitive instruments to pick up and translate the signals, it is possible, in my opinion, so to develop each of the three methods that by any one of them it will be possible to establish electric communication between England and America across the intervening space. It is certainly possible, either by conduction or by induction; whether by waves I am somewhat less certain. Conduction might very seriously interfere with other electric agencies, since the waste currents in the neighbourhood of the primary base line would be very great. It is certainly possible either by conduction or induction to establish direct communication across space with either the Cape, or India, or Australia (under the same assumptions as before), and at a far less cost than that of a connecting submarine cable.

"Instruments which operate by means of alternating currents of high frequency, like Mr Langdon-Davies's phonophore, are peculiarly liable to set up disturbance in other

circuits. A single phonophore circuit can be heard in lines a hundred miles away. When this first came to my notice it impressed me greatly, and coupled in my mind with the Ferranti incident mentioned above" (see note, p. 144, *supra*), "caused me to offer to one of my financial friends in the City, some eight years ago, to undertake seriously to establish telegraphic communication with the Cape, provided £10,000 were forthcoming to establish the necessary basal circuits in the two countries, and the instruments for creating the currents. My offer was deemed too visionary for acceptance. The thing, however, is quite feasible. The one necessary thing is the adequate base line or area. All the rest is detail."<sup>1</sup>

One word more. A press telegram of April 12, 1899, says: "The Wireless Telegraph Company have been approached by the representative of a proposed syndicate which desires to acquire the sole rights of establishing wireless telegraphic communication between England and America. The directors of the Company will consider the matter at their first meeting, which is fixed for an early date."<sup>2</sup>

Thus I end my task as I began it, with a dream—the self-same dream! As to its realisation in the distant future who can say nay?

"There are more things in heaven and earth, Horatio,  
Than are dreamt of in our philosophy."

<sup>1</sup> 'Journal, Society of Arts,' April 1, 1898.

<sup>2</sup> The syndicate must hurry up, as Mr Nikola Tesla is now on their track with a wireless telegraph that will "stagger humanity." We read ('Electrician,' January 19, 1900) that he is convinced he will soon be able to communicate, not only with Paris, but with every city in the world, and that at a speed of from 1500 to 2000 words per minute! See also p. 239, *supra*, for Prof. Fessenden's great hopes.